

INVERTER
FR-E800

E800



GLOBAL IMPACT OF MITSUBISHI ELECTRIC



Through Mitsubishi Electric's vision, "Changes for the Better" are possible for a brighter future.

Changes for the Better

We bring together the best minds to create the best technologies. At Mitsubishi Electric, we understand that technology is the driving force of change in our lives. By bringing greater comfort to daily life, maximizing the efficiency of businesses and keeping things running across society, we integrate technology and innovation to bring changes for the better.

Mitsubishi Electric is involved in many areas including the following

Energy and Electric Systems

A wide range of power and electrical products from generators to large-scale displays.

Electronic Devices

A wide portfolio of cutting-edge semiconductor devices for systems and products.

Home Appliance

Dependable consumer products like air conditioners and home entertainment systems.

Information and Communication Systems

Commercial and consumer-centric equipment, products and systems.

Industrial Automation Systems

Maximizing productivity and efficiency with cutting-edge automation technology.

Features	4	
Operation Panel, Operation Steps	36	1
Parameter List	38	2
Protective Functions	52	3
Standard Specifications	56	4
Outline Dimensions	59	5
Terminal Connection Diagram, Terminal Specifications	60	6
Example Connections	64	7
Options	66	8
Low-Voltage Switchgear/Cables	86	9
Precaution on Selection and Operation	92	10
Compatible Motors	98	11
Compatibility	102	12
Warranty	109	13
Support	112	14

Design future manufacturing

FR-E800—World's smallest class inverter with high functionality

Ever since the Industrial Revolution,
manufacturing technologies have evolved over the years.
And now, this is the time for new revolution.

A new era has started. Inverters are connected to the world.
We design future manufacturing and what's ahead.





E800

E800-E Ethernet model

E800-SCE Safety communication model



E800 Standard model



IoT



Smart factory made possible through industrial IoT

AI

Artificial intelligence (AI) supports users in various ways



The screen is under development.



E800

Real-time connection with the host IT system enables centralized or remote monitoring of operation, which further streamlines the production.

1 Improving usability by supporting CC-Link IE TSN as standard

Real-time production data can be collected using efficient protocols, and multiple protocols are supported on the same network, which provides a smart connection solution with various devices.

CC-Link IE TSN >> P13

2 Expanding a range of applications with multi-protocols

Multi-protocol support enables switching between various types of communication networks.

Inverter models that support protocols of major global industrial Ethernet networks are available.

**EtherNet/IP
PROFINET
EtherCAT, etc.** >> P13

3 Enabling flexible connection with two Ethernet ports

There is no need to use a switching hub.

Two Ethernet ports >> P14

AI technology and smartphone connectivity support initial startup or troubleshooting. Extensive maintenance functions will contribute to improvement in maintainability.

1 Reducing downtime using the AI function

The AI fault diagnosis function is used to identify the cause of a fault, enabling the fastest troubleshooting procedure.

AI fault diagnosis >> P27

2 Enhancing predictive maintenance

Integrating the world's first*1 "Corrosive-Attack-Level Alert System"*2 makes it possible to identify signs of inverter damage caused by corrosive gas. The environmental impact diagnosis function for the control circuit board enables visualization of the environment where the inverter is installed, enhancing maintainability and preventing faults.

Environmental impact diagnosis function >> P24

*1: According to our investigation as of September 10, 2019.

*2: Patent pending.

3 Further facilitating operation with your smartphone

Using smartphones or tablets, you can scan the QR code on the product to access the setup information, or you can access inverters via wireless remote network with a mobile app. This will contribute to reduction in startup time and improvement in maintainability.

Engineering software >> P28

Safety

Advanced harmony
between humans and
FA devices



Performance

Various solutions
achieved by the outstanding
drive performance

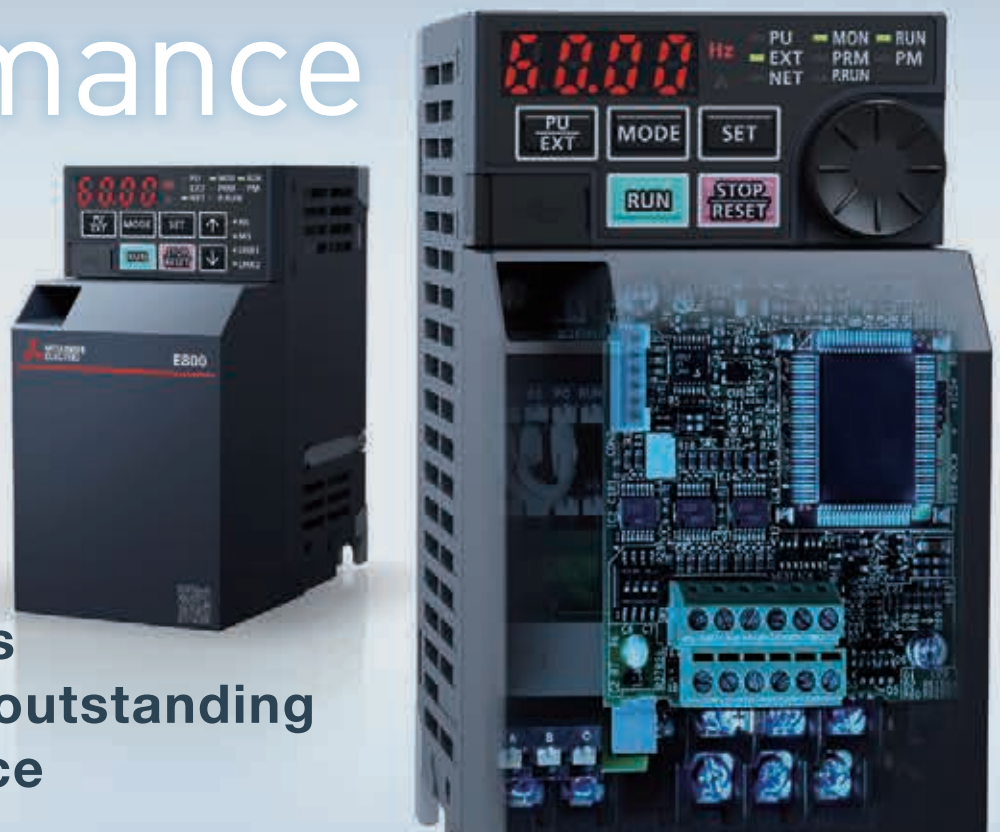

Available when the plug-in option is connected.

E800

Functional safety functions and wireless inverter connection enable stable and safe operation of the system.

1 Reducing the costs for safety

The inverter is compliant with safety integrity level (SIL) 2 or 3 of the IEC 61508 standard for functional safety.

Functional safety >> P21

2 Attaining both safety and productivity

Functions conforming to IEC 61800-5-2 ensure safe operation for users.

SLS function*1
(Safely-limited speed) >> P21

3 Ensuring operators' safety by wireless interfaces

Adjustments of inverter parameters and inverter monitoring can be performed wirelessly away from the system, ensuring operators' safety.

Ethernet connection*1 >> P20

*1: Several conditions must be met to use this function.

Various control methods are supported to expand applications in many systems.

1 Supporting various control methods

Various control methods such as Vector control (with encoder), Real sensorless vector control (without encoder), and positioning without using sensors are supported. Premium efficiency motors and PM motors are supported, enabling applications in various solutions.

Control method >> P19

2 Expanding applications with the enhanced product line

The product line is enhanced as compared to the preceding FR-E700 inverters.

- 18.5 kW / 22 kW supported
- 575 V class supported
- Surrounding air temperature of -20°C to 60°C*1
- Compliance with IEC 60721-3-3(3C2)*2 for corrosive gas concentration
- IP67 models (FR-E846)

Extended capacity range / improved environmental resistance >> P16

*1: Derating required for 50°C or higher.
*2: Coated model (-60) only

Useful functions for each of the design, operation, and maintenance processes of systems

FR-E800 inverters have various functions to attract more customers by offering safe and reliable operation for a long time.

This is the time to start innovation in the fields of manufacturing.

Design

1



Smart factory

Supporting various networks enable flexible system design.

P12-15

2



Wide range of applications

The extended range of capacities and dimensions supports various applications.

P16-17

3



Higher added values

The outstanding drive performance and various functions create higher added values.

P18-19

Operation

4



Improved safety

Humans and FA devices can work together by enhancing functional safety.

P20-21

5



Energy saving

Use of induction motors or IPM motors contributes to energy saving.

P22-23

Maintenance

6



Improved maintainability

Functions for residual life diagnosis, predictive maintenance, and preventive maintenance support stable system operation.

P24-25

7



Downtime reduction

When a fault occurs, AI analysis and other diagnosis functions solve the problem quickly.

P26-27

Engineering tools

8



Engineering software for further ease of operation

The work efficiency can be improved for each of the design, operation, and maintenance processes.

P28-31

1



Design

Smart factory

Supporting various networks enable flexible system design.



Smart factory

Office

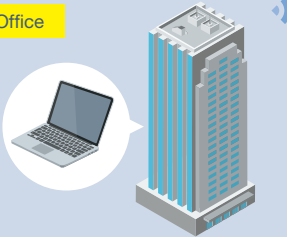

Real-time remote monitoring of operation of each factory enables interconnection between factories. In case of troubles, quick detection enables fast recovery.

Internet

Warehouse



Products are stored in a warehouse. Stock control information is shared with the office and the factories.

Factory A

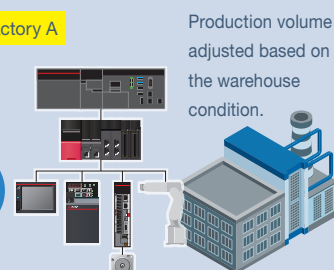

Production volume is adjusted based on the warehouse condition.

Factory B

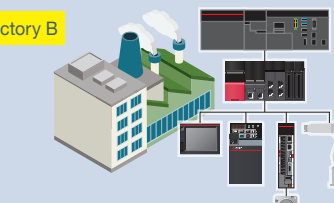

Production volume of Factory B is adjusted efficiently based on the production condition of Factory A.

1 Less workload required for system construction

▶ CC-Link IE TSN supported as standard

- Deterministic performance of cyclic communication is maintained even when mixed with slower information data (non real-time). This enables TCP/IP communication devices to be used without affecting overall control.
- Network device profiles are available to facilitate network construction.

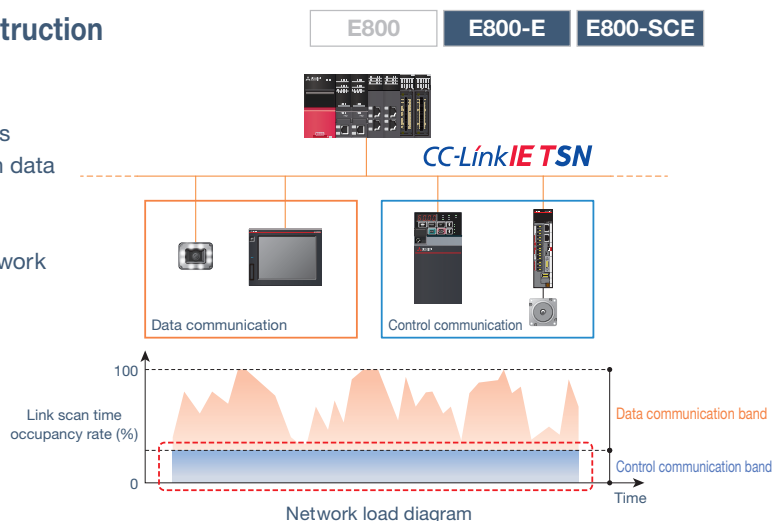

- Non-FA devices that support SLMP and TCP/IP communication can also connect to the network. Inverters can connect to a variety of devices, enabling use with versatile devices.

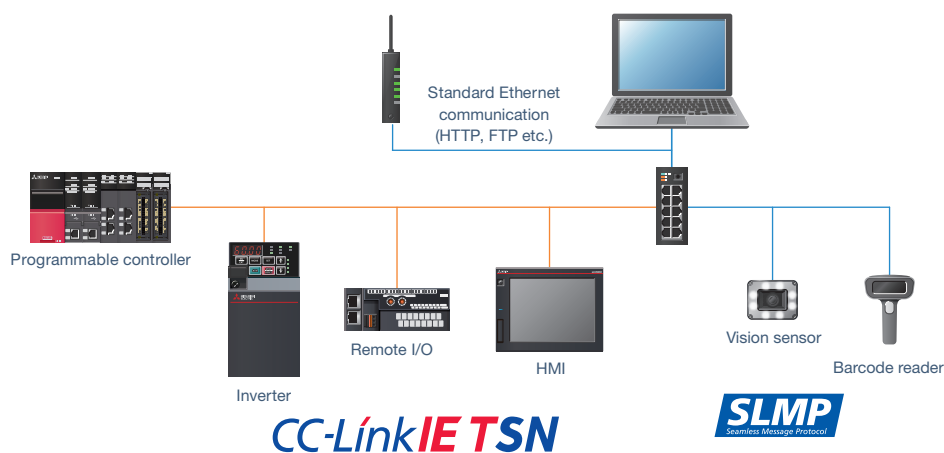

2 Compatibility with global networks

▶ Multi-protocols

Inverter models that support protocols of major global industrial Ethernet networks are available.

FR-E800 inverters support a variety of open networks without using any options, enabling the use of inverters on the existing network and assuring compatibility with various systems. Users can select a protocol group suitable for the intended system. It is possible to switch between protocols only by setting parameters. (Supported protocols differ depending on the model.)

Supported protocols

Model	CC-Link IE TSN (100 Mbps) ^{*1}	CC-Link IE Field Network Basic	MODBUS [®] /TCP	PROFINET	EtherNet/IP	BACnet/IP	EtherCAT
FR-E800-[]EPA	●	●	●	—	●	●	—
FR-E800-[]EPB	●	●	●	●	—	—	—
FR-E800-[]EPC	—	—	—	—	—	—	○

*1: 1 Gbps is optional (to be supported).

●: Supported ○: To be supported soon



Design Smart factory

Supporting various networks enable flexible system design.

3 Supporting various topologies

E800

E800-E

E800-SCE

▶ Two Ethernet ports

Two Ethernet ports are provided as standard, enabling flexible connection in line topology without using a switching hub. (A compatible master module is required for ring topology.)

Complex networks can be created just by connecting devices with a cable to a free port. The network can even accommodate changes in the specifications of devices.

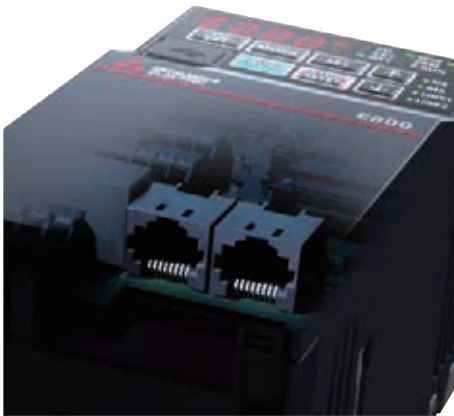

Line topology

The total wiring length can be minimized for large or extensive systems. Eliminating a switching hub allows more flexible installation of inverters even in a narrow space.

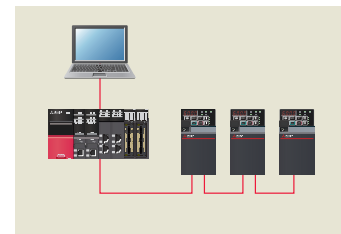

Star topology

A fault in one device does not affect other devices. Fast recovery is enabled when a fault occurs as it is easy to know which device is faulty.

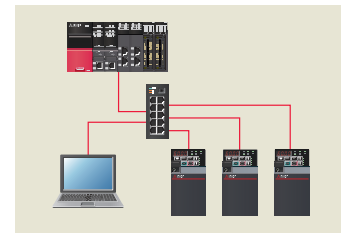

4 Enabling construction of a small-scale synchronous system of inverters

E800

E800-E

E800-SCE

▶ Inverter-to-inverter link function

Communication between multiple inverters is carried out through the I/O device and special register transmission of the PLC function (refer to page 18). A small-scale system can be created by connecting multiple inverters via Ethernet. (The FR-A800-E inverter or the FR-F800-E inverter can be mixed in the system.)

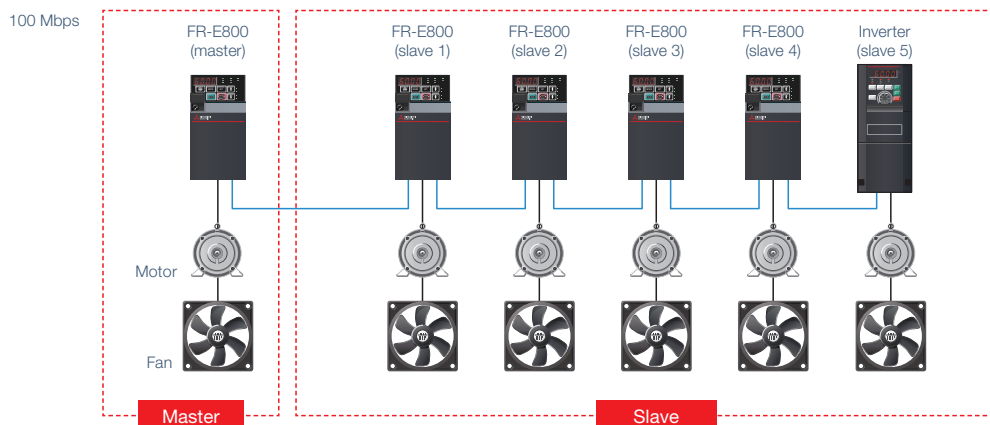

5 Simple configuration with less wiring using safety communication models

E800 E800-E **E800-SCE**

► Safety communication model To be supported soon

Safety communication models support Ethernet-based safety communication protocols certified as compliant with international standards. The safety control system on the existing network can be easily enhanced with less cost.

- CC-Link IE TSN Safety Function
- PROFI-safe
- CIP Safety
- FSoE (Safety over EtherCAT)

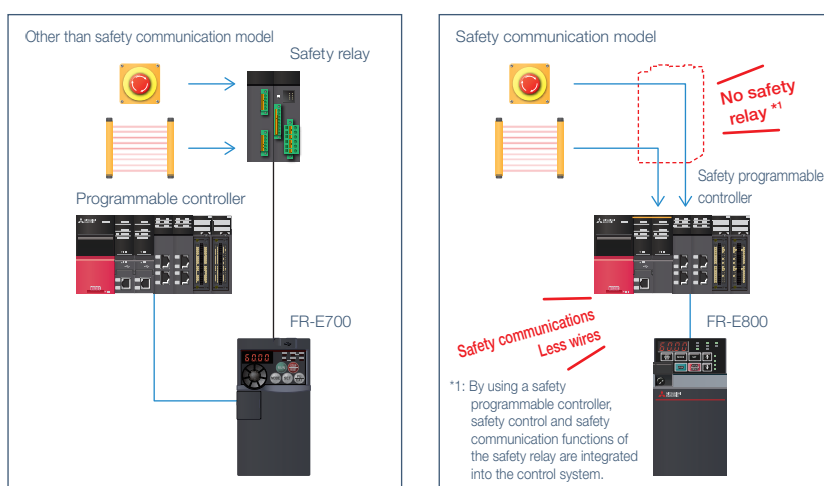

6 Security measures

E800 **E800-E** E800-SCE

► Ethernet IP filtering function

Set the IP address range for connectable network devices to limit connectable devices.

The Ethernet IP filtering function is a means to prevent unwanted access from external devices, but it does not prevent it completely.

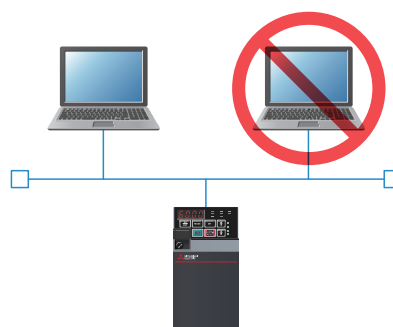

► Ethernet command source selection

Devices which can control the inverter can be limited by setting the IP address range of the network device(s) used to operate it.

► Ethernet function selection

Communication sockets are created only for selected applications such as CC-Link IE TSN or MODBUS/TCP to prevent unwanted access.

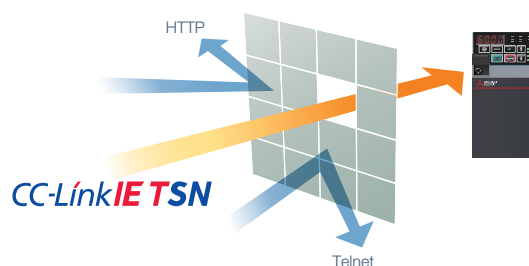

2



Design

Wide range of applications

The extended range of capacities and dimensions supports various applications.



1 Supporting various systems and environments

▶ Extended capacity range To be supported soon

The product line will be extended to include 18.5K and 22K inverters. This will allow use of inverters in large-scale systems.

▶ Increased environmental resistance

Various applications are supported by allowing for corrosive environments or a wide range of surrounding air temperatures.

- Surrounding air temperatures between -20°C and 60°C^{*1} are supported. (-10°C to $+50^{\circ}\text{C}$ for the FR-E700)
- Inverters with circuit board coating (IEC 60721-3-3(3C2))^{*2} are available for improved environmental resistance.

^{*1}: Derating required for 50°C or higher.

^{*2}: Coated model (-60) only.

E800

E800-E

E800-SCE



Water treatment plant



Painting line

2 Effective solution for downsizing equipment

▶ Multiple rating

Two rating types of different rated current and permissible load can be selected by setting parameters. The choice of inverters is widened for intended applications of users. When users select the LD rating for light duty applications, inverters with smaller capacities can be used as compared to the FR-E700 series inverters. For example, when the LD rating (light duty) is selected for a 22K inverter, the inverter can drive a motor with a capacity up to 30 kW.

Load	Rating	Overload current rating
Light duty	LD rating	120% 60 s, 150% 3 s (inverse-time characteristics) at surrounding air temperature of 50°C
Normal duty	ND rating	150% 60 s, 200% 3 s (inverse-time characteristics) at surrounding air temperature of 50°C

E800 E800-E E800-SCE



Building water pumps

3 Optimizing the layout inside the enclosure

▶ Flexible installation

When the surrounding air temperature is 40°C or less, multiple inverters can be installed side-by-side. Users can select the most suitable layout for the intended installation area.



Side-by-side installation

E800 E800-E E800-SCE



Ceiling crane

4 Enabling installation in various environments

▶ IP67 models (400 V class: 0.75K to 3.7K)

To be supported soon

Installation outside of the enclosure enables installation closer to machines (FR-E846). Since the inverter is compatible with hostile environments such as high humidity and dusty environments, users can easily install the inverter near the machine or in available spaces.

It is possible to reduce line noise by shortening the wiring length between the inverter and the motor.

E800 E800-E E800-SCE



Automotive production line

5 Improving productivity with shorter tact time by the enhanced regeneration function

▶ Built-in brake transistor

With the enhanced power regeneration capability (brake duty: 100% max.), deceleration time can be shortened.*1

*1 : For 200 V class 0.4K and 0.75K models, the brake duty is 30% ED maximum when the lowest resistance value is used. The brake resistor must have a sufficient capacity to consume the regenerative power.
For 200 V class 0.1K and 0.2K models, brake transistors are not built in.

▶ Increased excitation deceleration

To be supported soon

When the increased magnetic excitation deceleration function is used, the motor consumes the regenerative power and the deceleration time can be reduced without using a brake resistor.

The tact time can be reduced for a transfer line or the like.

E800 E800-E E800-SCE



Automotive production line



Airport baggage conveyor

3

Design

Higher added values

The outstanding drive performance and various functions create higher added values.



1 Customizing inverter operation for each machine

E800

E800-E

E800-SCE

▶ PLC function

In accordance with the machine specifications, users can set various operation patterns: inverter movements at signal inputs, signal outputs at particular inverter statuses, and monitor outputs, etc. Operation of the system can be customized by the inverter alone.

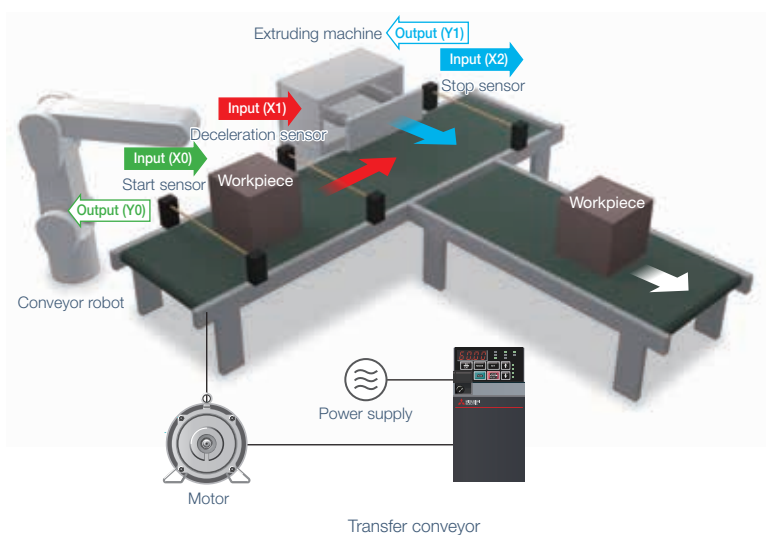

2 Same spare inverters for various applications

▶ Control method

Switching between control methods with the FR-E800 inverter, Vector control for lift application (with the plug-in option), Advanced magnetic flux vector control for conveyors, etc., reduces the number of required spare inverters.

PM sensorless vector control is available when inverters are used with PM motors. High-level control such as positioning control is enabled without using an encoder (to be supported).

E800	E800-E	E800-SCE
------	--------	----------

Control	Speed control	Torque control	Position control	Motor
V/F control	●	–	–	Induction motor
Advanced magnetic flux vector control	●	–	–	
Real sensorless vector control	●	●	–	
Vector control (with plug-in option FR-A8AP E kit used)	○	○	○	PM motor
PM sensorless vector control	●	–	○	

●: Supported ○: To be supported

▶ Offline auto tuning

Sensorless operation can be performed with non-Mitsubishi Electric general-purpose (induction) motors*1 and permanent magnet (PM) motors*1 as well as Mitsubishi Electric induction motors and PM motors.

Users can use existing motors with new inverters.

*1: Tuning may be disabled depending on the motor characteristics.

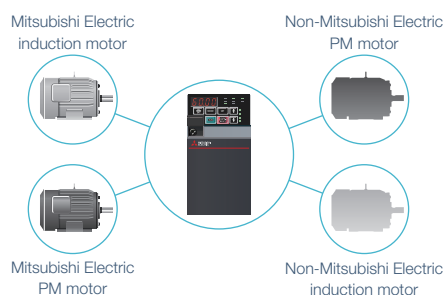

3 Improving work efficiency by powerful high-speed operation

▶ PM sensorless vector control

The torque is not reduced in the high-speed range (up to the rated speed) during PM sensorless vector control as compared with operation using a stepper motor. High-speed system operation improves the tact time.

E800	E800-E	E800-SCE
------	--------	----------

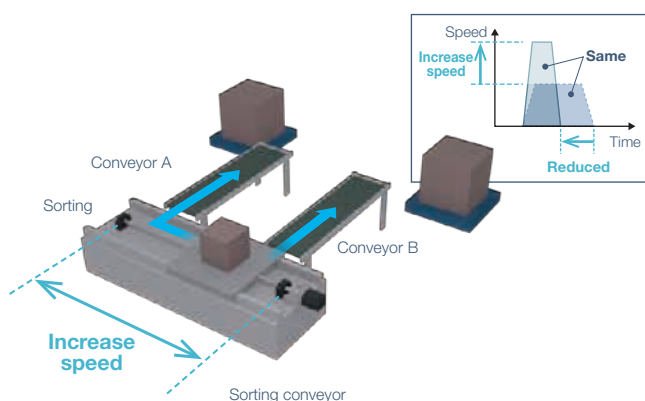

4 Expanding the range of applications using inverter options

▶ Plug-in options

In addition to the existing plug-in options to add digital inputs / analog outputs and to support different communication standards, the Vector control compatible option FR-A8AP E kit is supported. Among our compact inverters, the FR-E800 inverter is the first to support Vector control.

E800	E800-E	E800-SCE
------	--------	----------

FR-E800 inverter options

Model	Description	Supported
FR-A8AX E kit	16-bit digital input	●
FR-A8AY E kit	Digital output, additional analog output	●
FR-A8AR E kit	Relay output	●
FR-A8AP E kit	Vector control, encoder feedback control	○
FR-E8DS E kit	24VDC input	○
FR-A8NC E kit	CC-Link	●
FR-A8ND E kit	DeviceNet	○
FR-A8NP E kit	PROFIBUS-DP	○

●: Supported ○: To be supported

4



Operation

Improved safety

Humans and FA devices can work together by enhancing functional safety.



1 Wireless access with hard-to-reach inverters

E800 E800-E E800-SCE

▶ Ethernet communication

Even if inverters are located in a high place, narrow area, or other hard-to-reach place, wireless access enables adjustments of inverter parameters, inverter monitoring (simultaneous monitoring of multiple axes possible), and inverter maintenance such as life diagnosis checks.

The FR-E800 inverter can be connected to FR Configurator2 using a commercially-available industrial wireless LAN*1 access point.

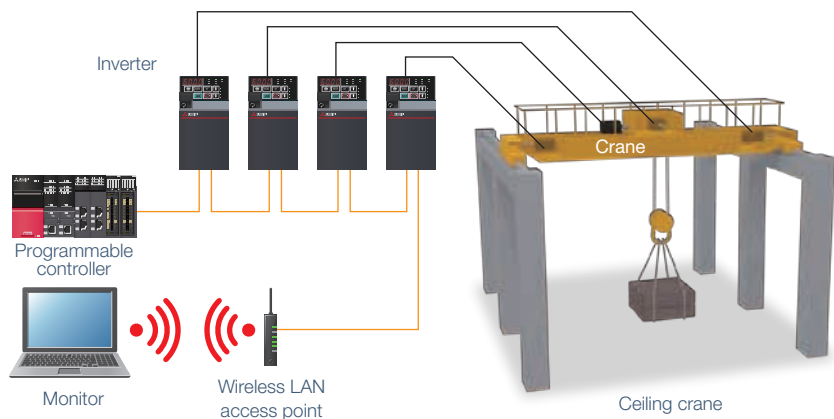

*1: A wireless LAN suitable for the industrial use in severe environments or in environments requiring high reliability (redundancy).

*2: Under certain environments or installation conditions, Ethernet communication through wireless LAN is not as stable as communication through wired LAN. Before starting operation, always check the communication status. Inverter operation (output shutoff, deceleration stop, etc.) when communication fails (due to reasons such as disconnection) can be selected by setting parameters. For applications requiring data transmission or update periodically or within a certain time period, a wired connection is recommended.

2 Attaining both safety and productivity

E800

E800-E

E800-SCE

► Functional safety

The inverter is compliant with safety integrity level (SIL) 2 or 3 of the IEC 61508 standard for functional safety. This will contribute to reduction in the initial safety certification cost.

The inverter supports various safety functions (IEC 61800-5-2), contributing to eliminating external devices or reducing maintenance time. (Note that several conditions must be met to use safety functions.) This will significantly reduce time required for maintenance or tooling and eliminate external devices such as ones used for monitoring the speed.

		FR-E800, FR-E800-E	FR-E800-SCE	FR-E700-SC
Functional safety category (ISO 13849-1, IEC 61508)		SIL2, PLd, Cat.3	SIL3, PLe, Cat.3	SIL2, PLd, Cat.3
STO	Safety torque off, coasting to stop	●	○	●
SS1	Safe stop 1, deceleration stop	-	○	-
SLS	Safely-limited speed	-	○	-
SBC	Safe brake control	-	○	-
SSM	Safe speed monitor	-	○	-

●: Supported ○: To be supported -: Not supported

STO (safe torque off) function

Driving power to the motor is electronically shut off by responding to the input signal from external equipment.

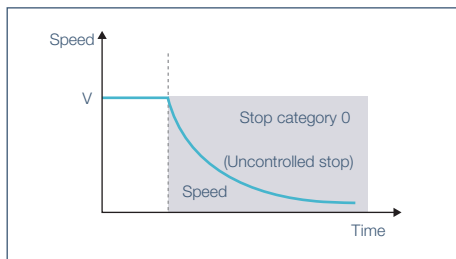

E800

E800-E

E800-SCE

Without STO function

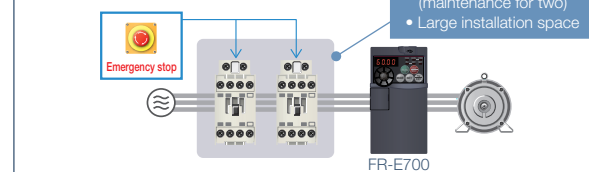

Two MCs required

- High cost
- High maintenance (maintenance for two)
- Large installation space

Use the STO function.

- Magnetic contactor (MC)
- Emergency stop wiring

Safety stop function (STO) cuts down the number of MCs to one! **

- Cost reduction / low maintenance (maintenance for one)
- Small installation space

With STO function

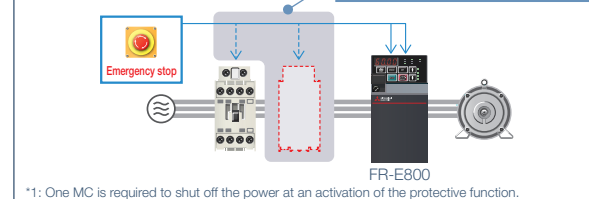

**1: One MC is required to shut off the power at an activation of the protective function.

SLS (safely-limited speed) function

To be supported soon

E800

E800-E

E800-SCE

Function to monitor the speed so that the predetermined speed limit is not exceeded. The motor speed is calculated without using an encoder. This will contribute to wire and cost savings. Several conditions must be met to use this function.

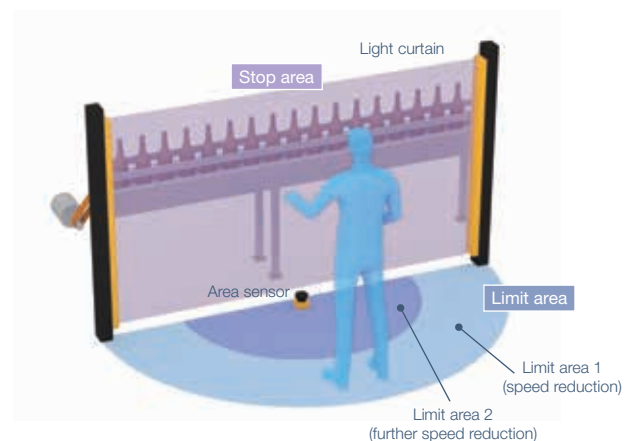
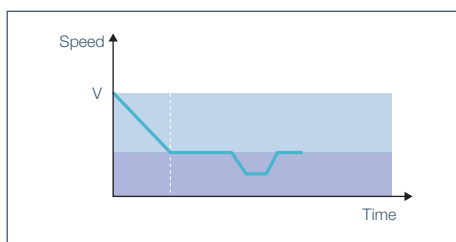



Use of induction motors or PM motors contributes to energy saving.



1 Energy saving with motors

▶ PM motor

The PM motor achieves even higher efficiency as compared to the general-purpose motor.

The setting for driving PM motors is enabled just by setting parameters.

Why is a PM motor so efficient?

- No current flows to the rotor (secondary side), and no secondary copper loss is generated.
- Magnetic flux is generated with permanent magnets, and less motor current is required.

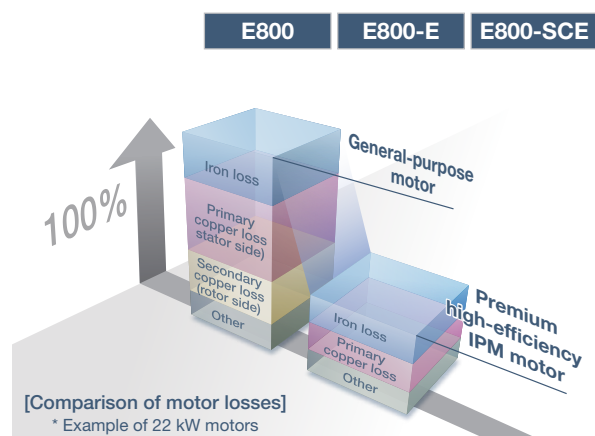

2 Supporting step-by-step energy saving solution

E800

E800-E

E800-SCE

► Compatibility with both induction motors and PM motors

Further energy saving operation is enabled by using IE3/IE4 induction motors or permanent magnet embedded (PM) motors. FR-E800 inverters support both induction motors and PM motors, enabling step-by-step replacement of existing devices. Users can replace inverters first and then motors. There is no need to replace them all at once.

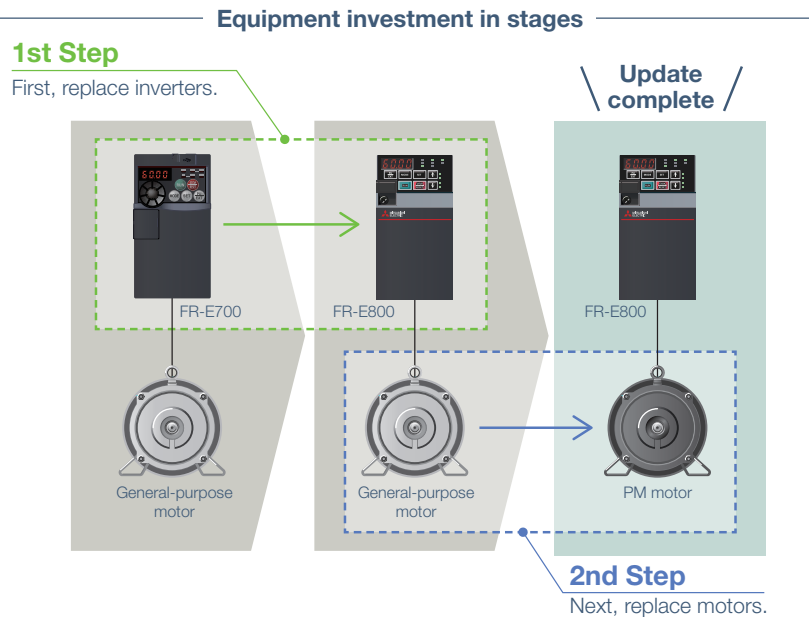

3 Energy saving with inverters

► Advanced optimum excitation control To be supported soon

A large starting torque can be provided with the same motor efficiency under Optimum excitation control. Without the need of troublesome adjustment of parameters (acceleration/deceleration time, torque boost, etc.), acceleration is done in a short time. Also, energy saving operation with the utmost improved motor efficiency is performed during constant-speed operation. When Advanced magnetic flux vector control is selected, Advanced optimum excitation control is available.

► Energy saving monitoring

The energy saving effect can be checked using an operation panel, output terminal, or network. The output power amount measured by the inverter can be output in pulses. The cumulative power amount can be easily checked.*1

*1: This function cannot be used as a meter to certify electricity billings.

E800

E800-E

E800-SCE

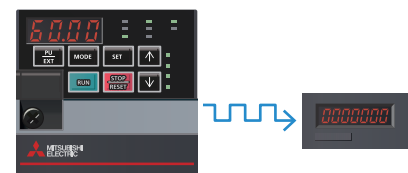

4 Energy saving with the regenerative option

► Power regeneration function (optional)

While the motor rotates to drive the machine during power driving, the machine rotates the motor during regenerative driving, which results in energy saving since the motor serves as a generator which returns the power to the power supply. By using the multifunction regeneration converter (FR-XC) as a common converter, the power returned from an inverter during regenerative drive can be supplied to another inverter, which in turn saves energy.

E800

E800-E

E800-SCE

[Power regeneration]

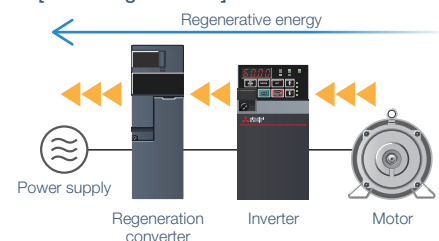



Functions for residual life diagnosis, predictive maintenance, and preventive maintenance support stable system operation.

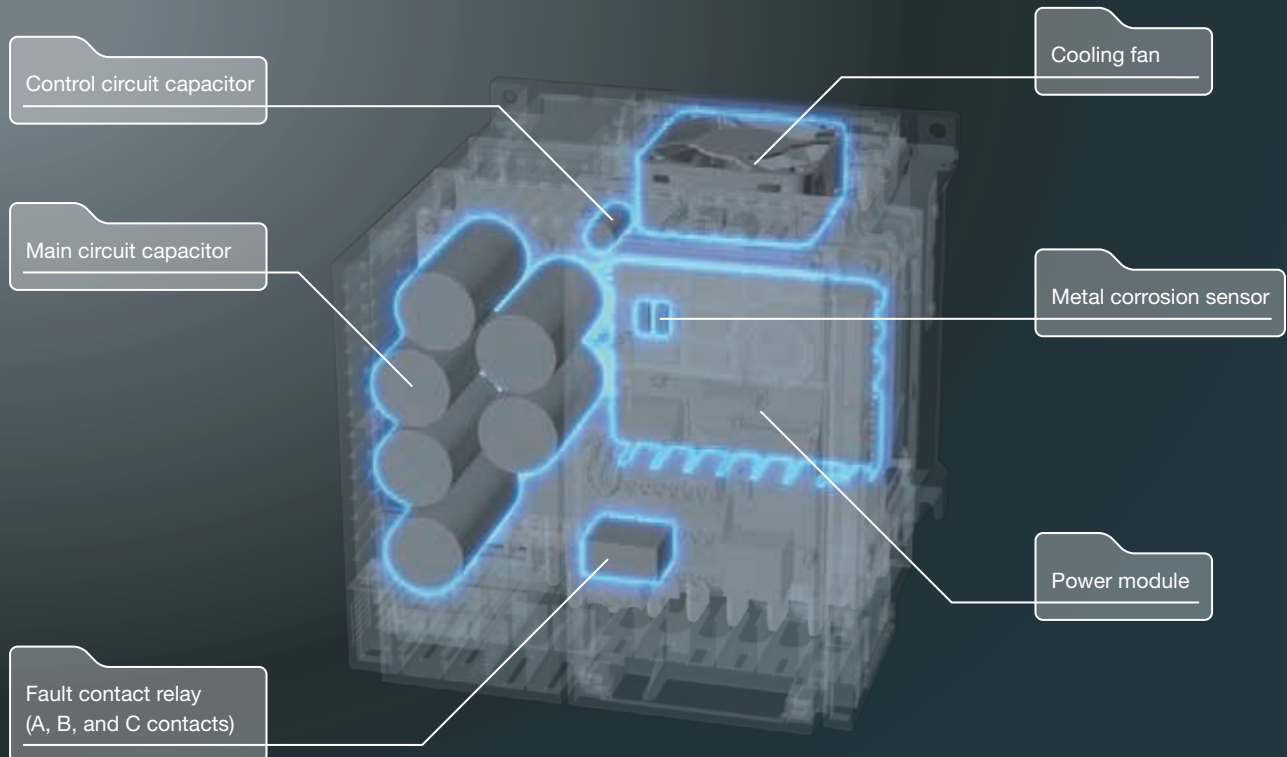

Example: FR-E840-3.7K

1 Supporting scheduled maintenance planning

► Environmental impact diagnosis function

The world's first*¹ Corrosive-Attack-Level Alert System*² makes it possible to identify signs of inverter damage caused by hydrogen sulfide or other corrosive gas. Equipment downtime will be reduced as the function notifies operators when the production environment needs to be improved (for coated models (-60) only).

*1: According to our investigation as of September 10, 2019.

*2: Patent pending.

► Enhanced life diagnosis function

Availability of life diagnosis checks is extended. This enhanced diagnosis function ensures reliable operation of the system.

The design life of cooling fans and capacitors has been extended to 10 years*³.

*3: Surrounding air temperature: annual average 40°C (free from corrosive gas, flammable gas, oil mist, dust and dirt)
Output current: 80% of the inverter ND rating
Since the design life is a calculated value, it is not a guaranteed value.



Sewage treatment plant

- Extended**
- Main circuit capacitor residual-life estimation
 - Inverter fault contact relay (A, B, and C contacts) life diagnosis*⁴
 - Display power cycle life diagnosis
 - Control circuit capacitor life diagnosis
 - Cooling fan life diagnosis
 - Inrush current limit circuit life diagnosis

*4: Terminals A, B, and C of the inverter

2 Real-time monitoring for early fault detection

E800

E800-E

E800-SCE

▶ Load characteristics fault detection function

When a mechanical fault such as clogging of the filter occurs, the inverter outputs a warning or shuts off the output to prevent system damage.

The speed-torque characteristic is stored while no fault occurs, enabling comparison between the measured data and the stored data.

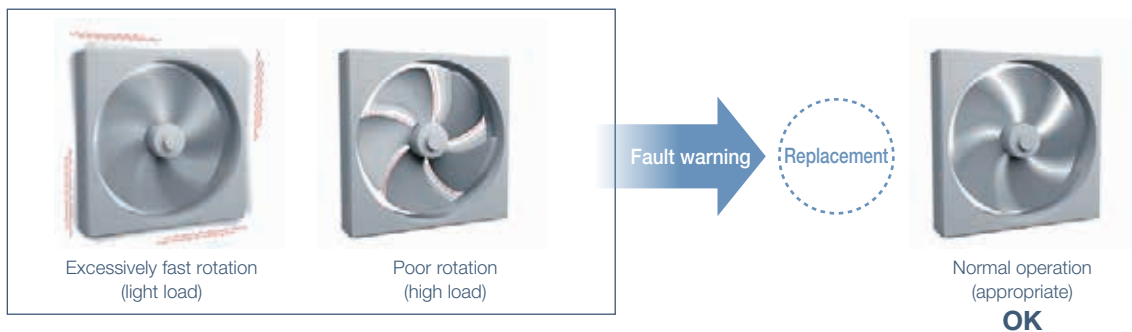

▶ Current detection function

Faults caused by stiff rotation of motor shaft (increased load) or cracks in the belt (decreased load) can be detected through the motor output current.

If the output current exceeds the predetermined value, a signal is output to inform the user of the faulty device.

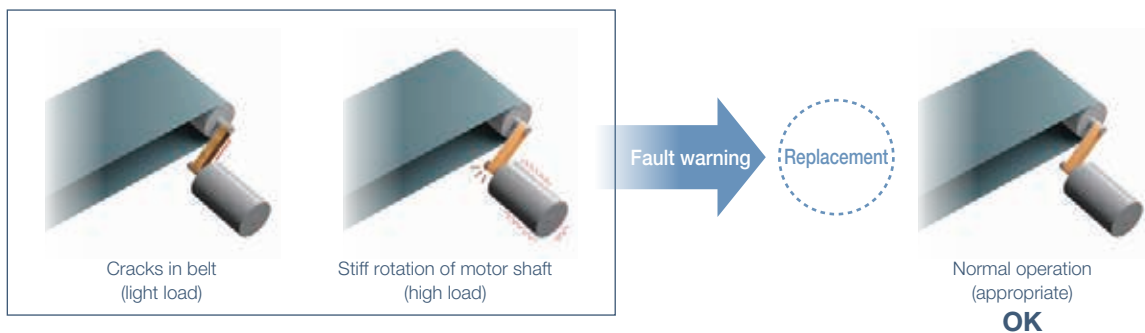

3 Supporting preventive maintenance of peripherals

E800

E800-E

E800-SCE

▶ Maintenance timer

The Maintenance timer signal is output when the inverter's cumulative energization time reaches the time period set with the parameter. This can be used as a guide for when the maintenance of the equipment should be conducted.

4 Thorough customer support

E800

E800-E

E800-SCE

▶ FA Center network

Our global network offers reliable technical support and customer satisfaction. (Refer to page 112.)

▶ Setup information web page

Our setup information web page provides easy access to manuals, videos, and outline dimension drawings.





Maintenance

Downtime reduction

When a fault occurs, AI analysis and other diagnosis functions solve the problem quickly.



1 Streamlining the installation process

► **Compatible installation size**

E800

E800-E

E800-SCE

The installation size was determined to assure exchangeability with the FR-E700 series. Installation interchange attachment options are available for facilitating replacement with the models of different size (FR-E820-3.7K, FR-E840-0.4K/0.75K/1.5K).

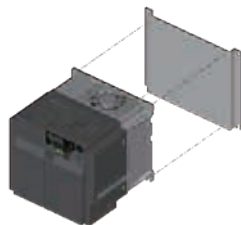

2 Quick reaction to troubles

► **Power supply from USB port**

E800

E800-E

E800-SCE

With the power supplied from the computer (USB bus power connection)*1, parameters can be set while the main circuit power supply is OFF.

Maintenance can be performed quickly and safely.

*1: The maximum SCCR should be 500 mA. A PU connector cannot be used during USB bus power connection.



E800

E800-E

E800-SCE

3 Easy and fast wiring

► **Spring clamp terminals**

- Spring clamp terminals have been adopted for control circuit terminals for easy wiring. Furthermore, wires can be protected against loosening or contact faults due to vibrations during operation on a bogie or during transport. No additional screw tightening is required.



	FR-E800	FR-E800-E	FR-E800-SCE
Input terminal	7	2	0
Output terminal	Open collector	0	0
	Relay	1	1

4 Troubleshooting supported by AI technology

E800

E800-E

E800-SCE

▶ AI fault diagnosis

The inverter is connected to the engineering software, FR Configurator2, in which Maisart*1 (Mitsubishi Electric's AI technology) is integrated to analyze data and help identify the cause of a fault.

This function enables the fastest troubleshooting procedure without requiring any special skills, which contributes to downtime reduction.



Maisart

*1: Maisart is Mitsubishi Electric's brand of AI technology. The name stands for "Mitsubishi Electric's AI creates the State-of-the-ART in technology". This means that it is using our proprietary AI technology to make everything smarter.

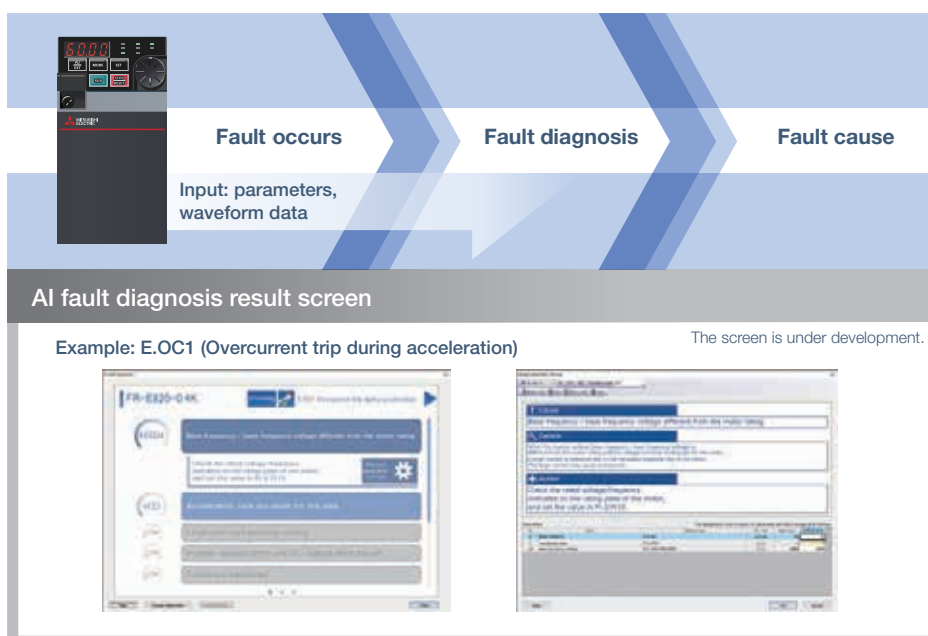

5 Trouble analysis from a remote location

E800

E800-E

E800-SCE

▶ Trace function

The operating status (output frequency or other data) immediately before the protective function is activated can be stored in a data file.

Users can read the data file in FR Configurator2 for graph display or send it by e-mail to someone away from the worksite, which facilitates the trouble analysis.

▶ Clock function

Setting the time*1 enables the user to specify the protective function activation time.

The date and time are also saved with the trace data, making the fault analysis easier.

Time synchronization via CC-Link IE TSN communication is available for the Ethernet model.

The internal clocks of connected devices on the CC-Link IE TSN Network can be synchronized.

*1: The clock is reset at power-OFF.

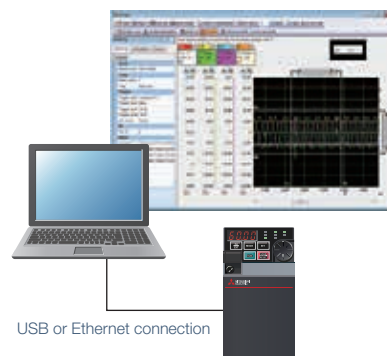



Engineering software for further ease of operation

The work efficiency can be improved for each of the design, operation, and maintenance processes.

1 FR Configurator2 for further ease of operation

Using FR Configurator2, easy-to-use software assisting anything from setup to maintenance, much more useful functions are available for users.

E800 E800-E E800-SCE

Free trial version Functions

The function with the marking above is available in the free trial version (usable free of charge with limited functions). It can be downloaded at Mitsubishi Electric FA Global Website.

Function	Free trial version	Function	Free trial version
Parameter list	○	Developer	×
Diagnosis	○	USB memory	×
AI fault diagnosis	×	parameter copy file edit	○
Graph	×	Ethernet parameter setting	○
Batch monitor	×	iQSS backup file conversion	○
Test operation	○	Help	○
I/O terminal monitor	×		

○: Supported
×: Not supported

A full functional trial version, which has the same functionality as the release version, is also offered for a limited period of 20 days.

▶ Life diagnosis check Free trial version Functions

Parts service life data is displayed in a dedicated window. A warning icon is shown in the alarm field of the parts recommended for replacement.

This can be used as a guideline to replace long life parts.



▶ Graph function—Automatic sampling when a fault occurs

Waveform graph data immediately before the protective function is activated can be automatically obtained.

Graph display and log analysis are available using the stored trace data.



▶ Ethernet parameter setting Free trial version Functions

Inverters in the same subnet mask are automatically detected, supporting easy network setting.

1) Detect supported devices.



2) Enter the network No., station No., IP address, and subnet mask.

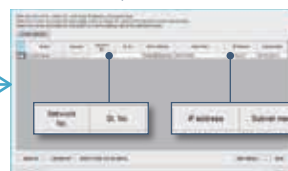

Setting complete

▶ Diagnostics (Fault history)

Fault records in the inverter can be displayed. When the clock function or CC-Link IE TSN communication is used, the time of fault occurrence can be displayed, too. It is possible to check the occurrence time and the type of faults, which is helpful in identifying causes of faults.



2 Further facilitating operation with your smartphone

E800

E800-E

E800-SCE

▶ Setup information web page

Users can scan the QR code on the product to directly access the setup information. Manuals, setup videos, and outline dimension drawings are available.

▶ Mobile app

To be supported soon

E800

E800-E

E800-SCE

Wireless access with inverters from a remote location enables setting or changing of parameters, starting and stopping, and monitoring on the screen of mobile devices.

Users can easily monitor the inverter operation by checking data such as the running frequency and status of input and output terminals at a glance in one screen.

Wireless communication equipment must be prepared in the system that includes the inverter.

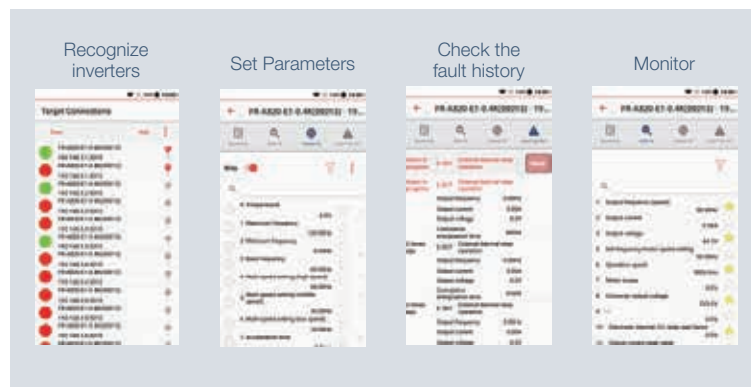



Engineering tools

Engineering software for further ease of operation

The work efficiency can be improved for each of the design, operation, and maintenance processes.

3 Further facilitating operation with the capacity selection software To be supported soon

E800 **E800-E** **E800-SCE**

Users can select motors by entering data of mechanical configuration, specifications, and operating patterns. Applicable combinations include inverters, sensorless servo drive units, and AC servo amplifiers. The most suitable combination can be selected from the selection result. The software also supports multi-axis systems. Twelve types of load mechanism such as a ball screw or a rack and pinion are selectable. Selection is available by following the steps from 1 to 3. When users include the power regeneration common converter or other applicable converter, the capacity of the converter can be selected at the same time.

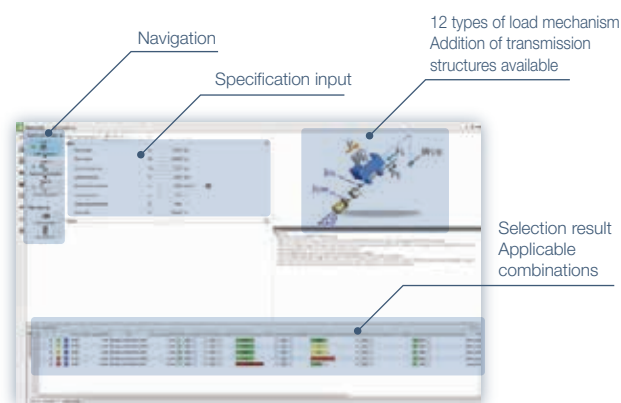

4 Further facilitating operation with the selection guide software To be supported soon

E800 **E800-E** **E800-SCE**

Advanced search for optimum inverters is available. Users can select inverters by entering data such as the motor capacity and current value and specifying specifications. The time spent on inverter selection can be reduced.

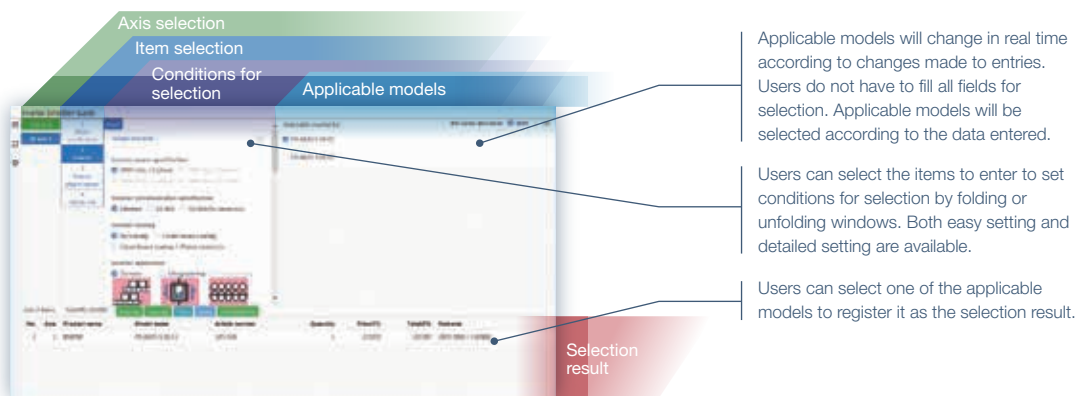

Applicable models will change in real time according to changes made to entries. Users do not have to fill all fields for selection. Applicable models will be selected according to the data entered.

Users can select the items to enter to set conditions for selection by folding or unfolding windows. Both easy setting and detailed setting are available.

Users can select one of the applicable models to register it as the selection result.

5 Further facilitating operation with Edgexcross

E800 **E800-E** **E800-SCE**

Inverters and the system are integrated by maximizing the use of production data with edge computing, enabling solutions for various issues including productivity improvement and equipment maintenance.

- Integration and processing of data sent from various devices and systems in production lines
- Real-time feedback to production sites
- Monitoring of field devices based on the know-how of production sites

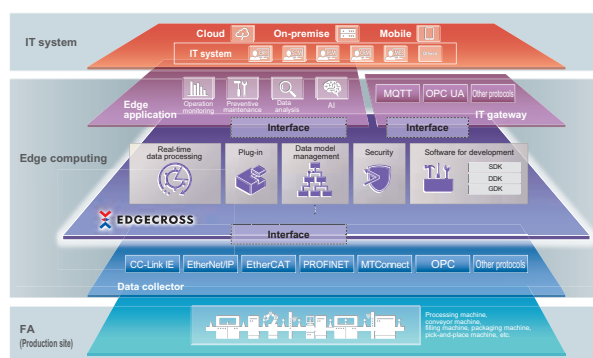

6 Further facilitating operation with GOT interaction functions To be supported soon

E800

E800-E

E800-SCE

GOT Drive

Enhanced compatibility between inverters and the GOT (human machine interface) brings various benefits to users.

Connection with the GOT2000 series can be established just by setting the station number. Other necessary settings are automatically done.

▶ Less time spent on screen design work by importing sample screens

Various sample screens*1 are available to enable parameter setting, batch monitor, measurement of load characteristics and so on using the GOT.

Using sample screens enables easy startup of the system.

*1: Sample screens are included in the GT Works3 (Ver. 1.205P or later) package, or can be downloaded at Mitsubishi Electric FA Global Website.

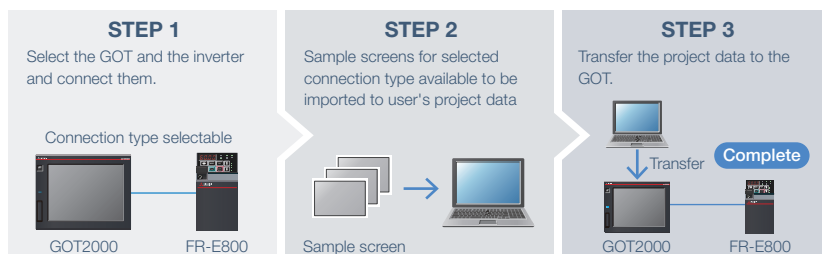

▶ Improving work efficiency without using a computer

Users can use the GOT to set up, adjust, and perform maintenance for inverters without using a computer.



▶ Immediate warning of system errors

By storing the data of relationship between the output frequency and the torque during normal inverter operation, users can judge whether the load is operating in normal condition. By outputting out-of-range warnings if applicable, users can detect mechanical faults or perform maintenance.

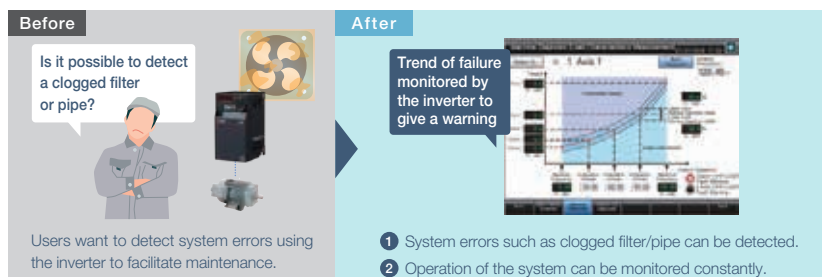

▶ Reducing downtime by interacting with the GOT

Faults occurred in the inverter can be displayed on the GOT screen. When a fault occurs, it is possible to identify the cause immediately, which contributes to downtime reduction.

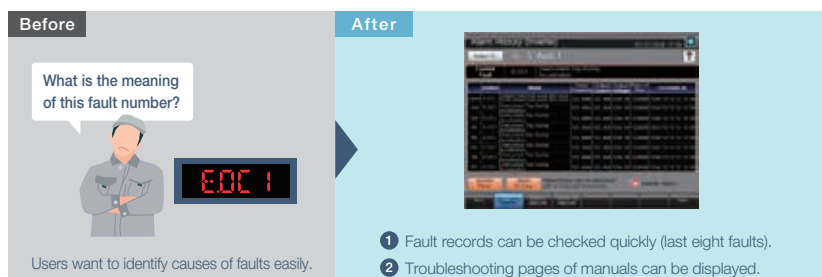

Application examples

CASE 1 Smart factory

Problem

It is difficult to monitor the operating condition of the equipment due to the diversified.

Solution

The inverter supports various industrial networks. It is possible to select the inverter according to the existing network. Two Ethernet ports are provided, enabling easy wiring.

Multi-protocols

Users can select a group of protocols that includes CC-Link IE TSN, MODBUS/TCP, PROFINET, EtherNet/IP, and EtherCAT suitable for the intended system. It is possible to switch between protocols only by setting parameters. (Supported protocols differ depending on the product model.)

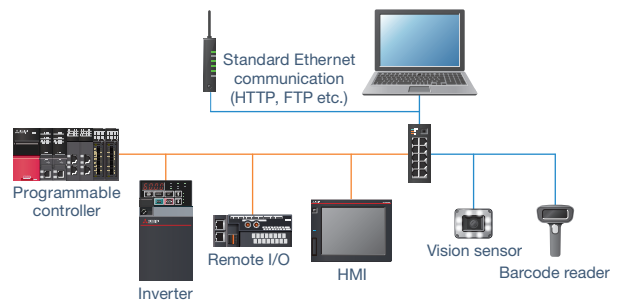

CASE 2 Fans and pumps

Problem

Is it possible to reduce downtime by predicting faults of the inverter or peripheral devices or problems arising from environmental causes?

Solution

AI-based troubleshooting reduces equipment downtime. The world's first environmental impact diagnosis function or other self-diagnostics allow early prevention or prediction of faults of the inverter or peripheral devices.

AI fault diagnosis

By connecting the inverter and a computer (USB or Ethernet), users can use FR Configurator2 to analyze data and help identify the cause of a fault. This diagnosis function enables the fastest troubleshooting procedure without requiring any special skills.

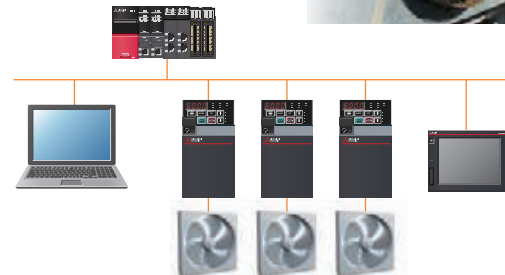

CASE 3 Transfer system

Problem

Is it possible to simplify the electric control system to use a smaller enclosure?

Solution

Inverter operations can be freely customized using the PLC function in the inverter. This function enables construction of various systems without using programmable controllers.

PLC function

In accordance with the machine specifications, users can set various operation patterns: inverter movements at signal inputs, signal outputs at particular inverter statuses, and monitor outputs, etc. Operation of the system can be customized by the inverter alone.

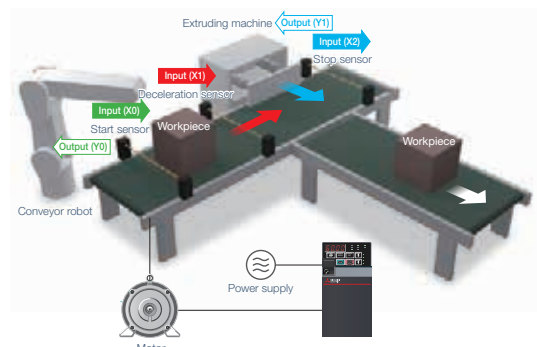

CASE 4 Food processing line

Problem

Is it possible to increase productivity while ensuring the safety of operators?

Solution

The inverter supports the IEC 61508-5-2 functional safety standard. This will significantly reduce time required for maintenance or tooling and eliminate external devices such as ones used for monitoring the speed.



SLS (safely-limited speed) function

It is possible to continue operation at a safe speed without stopping the production line. The motor speed is calculated based on the current value or other data without using an encoder. This will contribute to wire and cost savings.

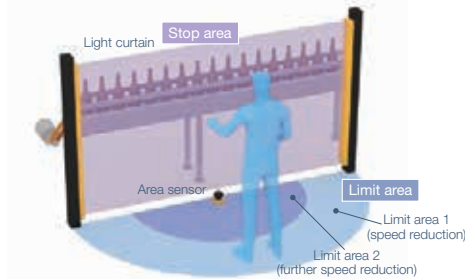

CASE 5 Cutting machine

Problem

Is it possible to reduce variation in the finished products?

Solution

Using PM sensorless vector control, the inverter contributes to reducing variation caused by uneven rotation.



PM sensorless vector control

The speed and magnetic pole positions, the two essential bits of information to control a PM motor, are detected without a sensor (encoder). The speed detection internally-performed in an inverter enables highly accurate control of a PM motor, almost as accurate as an AC servo system, without the need of a sensor (encoder).

Speed fluctuation ratio: $\pm 0.05\%$ (digital input)
 Speed fluctuation ratio = $(\text{Speed under no load} - \text{Speed under rated load}) / \text{Rated speed} \times 100(\%)$

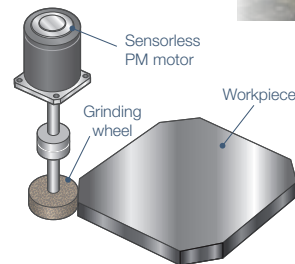

CASE 6 Sprinkler

Problem

Is it possible to reduce the amount of water except for daytime hours?

Solution

The inverter has the PLC function to change its operation according to the weather or time of day.



PLC function

The inverter can be run in accordance with a sequence program. Inverter control such as inverter operations triggered by input signals, signal output based on inverter operation status, and monitor output can be freely customized based on the machine specifications.

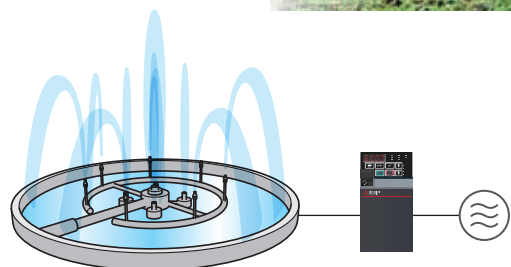

Lineup

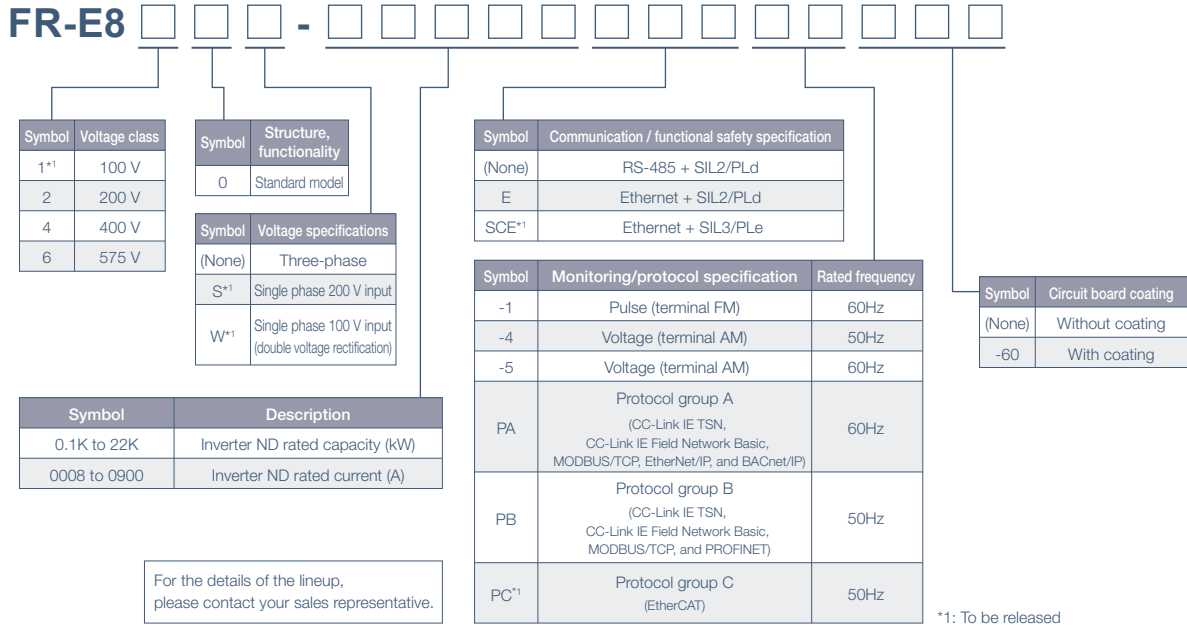

Three-phase 200 V	0.1K	0.2K	0.4K	0.75K	1.5K	2.2K	3.7K	5.5K	7.5K	11K	15K	18.5K	22K
	0008	0015	0030	0050	0080	0110	0175	0240	0330	0470	0600	0760	0900
FR-E820-[(E)]	●	●	●	●	●	●	●	●	●	○	○	○	○
FR-E820-[(S)SCE]	○	○	○	○	○	○	○	○	○	○	○	○	○
Three-phase 400 V	—	—	0.4K	0.75K	1.5K	2.2K	3.7K	5.5K	7.5K	11K	15K	18.5K	22K
	—	—	0016	0026	0040	0060	0095	0120	0170	0230	0300	0380	0440
FR-E840-[(E)]	—	—	●	●	●	●	●	●	●	○	○	○	○
FR-E840-[(S)SCE]	—	—	○	○	○	○	○	○	○	○	○	○	○
Three-phase 575 V	—	—	—	0.75K	1.5K	2.2K	3.7K	5.5K	7.5K	—	—	—	—
	—	—	—	0017	0027	0040	0061	0090	0120	—	—	—	—
FR-E860-[(E)]	—	—	—	●	●	●	●	●	●	—	—	—	—
FR-E860-[(S)SCE]	—	—	—	○	○	○	○	○	○	—	—	—	—
Single-phase 200 V	0.1K	0.2K	0.4K	0.75K	1.5K	2.2K	—	—	—	—	—	—	—
	0008	0015	0030	0050	0080	0110	—	—	—	—	—	—	—
FR-E820S-[(E)SCE]	○	○	○	○	○	○	—	—	—	—	—	—	—
Single-phase 100 V	0.1K	0.2K	0.4K	0.75K	—	—	—	—	—	—	—	—	—
	0008	0015	0030	0050	—	—	—	—	—	—	—	—	—
FR-E810W-[(E)SCE]	○	○	○	○	—	—	—	—	—	—	—	—	—

● : Released, ○ : To be released, --- : Not applicable



List of inverters by rating

200 V class

Model FR-E820-[]		Applicable motor capacity (kW)*1	
		LD	ND
0.1K	0008	0.2	0.1
0.2K	0015	0.4	0.2
0.4K	0030	0.75	0.4
0.75K	0050	1.1	0.75
1.5K	0080	2.2	1.5
2.2K	0110	3	2.2
3.7K	0175	5.5	3.7
5.5K	0240	7.5	5.5
7.5K	0330	11	7.5

400 V class

Model FR-E840-[]		Applicable motor capacity (kW)*1	
		LD	ND
0.4K	0016	0.75	0.4
0.75K	0026	1.5	0.75
1.5K	0040	2.2	1.5
2.2K	0060	3	2.2
3.7K	0095	5.5	3.7
5.5K	0120	7.5	5.5
7.5K	0170	11	7.5

575 V class

Model FR-E860-[]		Applicable motor capacity (kW)	
		LD	ND
0.75K	0017	1.5	0.75
1.5K	0027	2.2	1.5
2.2K	0040	3.7	2.2
3.7K	0061	5.5	3.7
5.5K	0090	7.5	5.5
7.5K	0120	11	7.5

Overload current rating

LD	120% 60 s, 150% 3 s (inverse-time characteristics) at surrounding air temperature of 50°C
ND	150% 60 s, 200% 3 s (inverse-time characteristics) at surrounding air temperature of 50°C

*1: The applicable motor capacity indicated is the maximum capacity applicable for use of the Mitsubishi Electric 4-pole standard motor.

MEMO

Operation Panel

● Basic Operation E800

◆ Components of the operation panel

The operation panel cannot be removed from the inverter.

	Name	Description
	PU/EXT key	Switches between the PU operation mode, the PUJOG operation mode, and the External operation mode.
	MODE key	Switches the operation panel to a different mode.
	SET key	Used to confirm each selection. Switches the monitor screen in the monitor mode.
	RUN key	Start command The direction of motor rotation depends on the Pr.40 setting.
	STOP/RESET key	Used to stop operation commands. Used to reset the inverter when the protective function is activated.
	Setting dial	The setting dial of the Mitsubishi Electric inverters. Turn the setting dial to change the setting of frequency or parameter.

◆ Starting/stopping the inverter on the operation panel

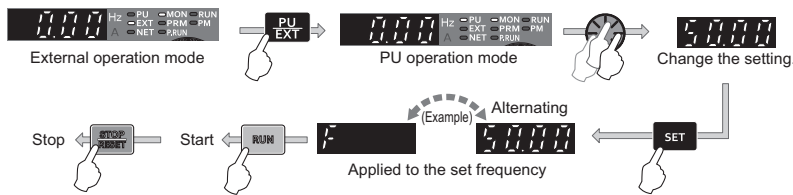

◆ Parameter setting

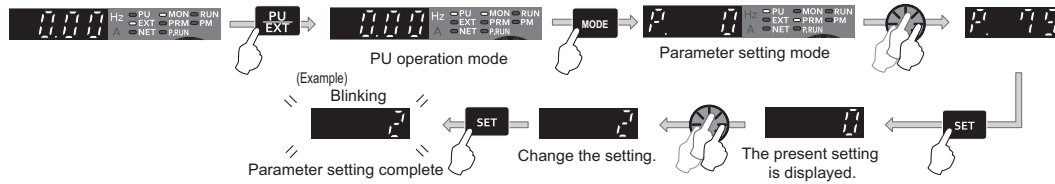

● Basic Operation E800-E

◆ Components of the operation panel

The operation panel cannot be removed from the inverter.

	Name	Description
	PU/EXT key	Switches between the PU operation mode, the PUJOG operation mode, and the External operation mode.
	MODE key	Switches the operation panel to a different mode.
	SET key	Used to confirm each selection. Switches the monitor screen in the monitor mode.
	RUN key	Start command The direction of motor rotation depends on the Pr.40 setting.
	STOP/RESET key	Used to stop operation commands. Used to reset the inverter when the protective function is activated.
	UP/DOWN key (↑ ↓)	Press this key to change the setting of frequency or parameter.

◆ Starting/stopping the inverter on the operation panel

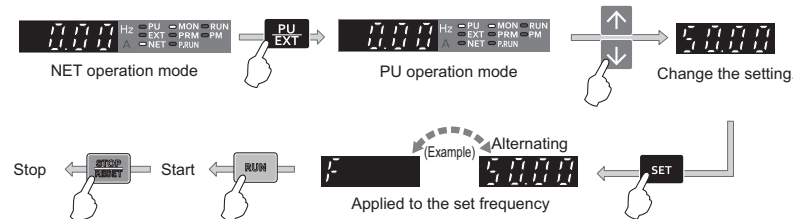

◆ Parameter setting

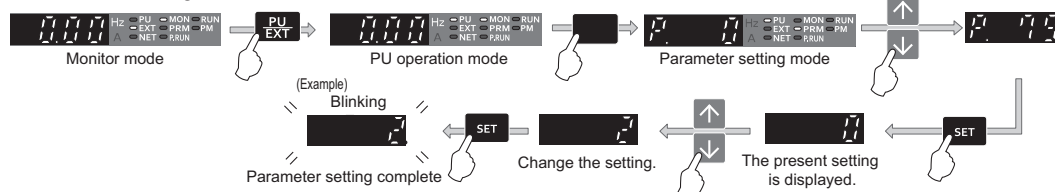

Operation Steps

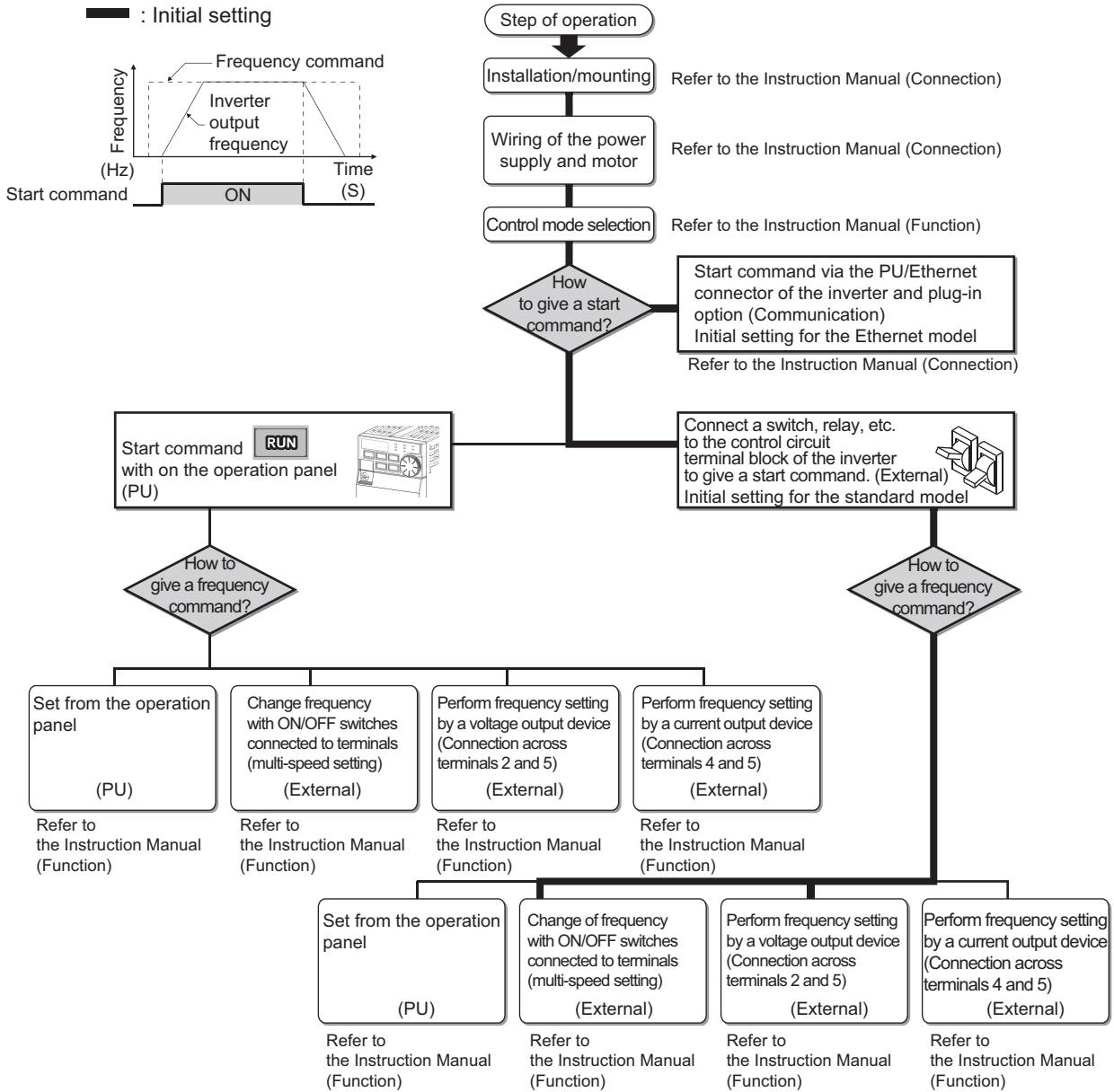

Parameter list

For simple variable-speed operation of the inverter, the initial values of the parameters may be used as they are. Set the necessary parameters to meet the load and operational specifications. Parameter's setting, change and check can be made on the operation panel.

NOTE

- **Simple** indicates simple mode parameters. Use Pr.160 User group read selection to indicate the simple mode parameters only (initial setting is to indicate the extended mode parameters).
- The changing of the parameter settings may be restricted in some operating statuses. Use Pr.77 Parameter write selection to change the setting of the restriction.
- Refer to for instruction codes for communication and availability of Parameter clear, all clear, and Parameter copy.

Notation

- [E800]: Available for the standard model.
- [E800-1]: Available for the FM type inverter (standard model).
- [E800-4]: Available for the AM (50 Hz) type inverter (standard model).
- [E800-5]: Available for the AM (60 Hz) type inverter (standard model).
- [E800-E]: Available for the Ethernet model.
- [E800-EPA]: Available for the Protocol group A (Ethernet model).
- [E800-EPB]: Available for the Protocol group B (Ethernet model).
- [200/400 V class]: Available for the 200/400 V class.
- [575 V class]: Available for the 575 V class inverters.

2

Parameter list

Function	Pr.	Pr. group	Name	Setting range	Minimum setting increments	Initial value*1		Customer setting
						Gr.1	Gr.2	
Basic function	0	G000	Torque boost Simple	0% to 30%	0.1%	6%*2		
						5%*2		
						4%*2		
						3%*2		
						2%*2		
	1	H400	Maximum frequency Simple	0 to 120 Hz	0.01 Hz	120 Hz		
	2	H401	Minimum frequency Simple	0 to 120 Hz	0.01 Hz	0 Hz		
	3	G001	Base frequency Simple	0 to 590 Hz	0.01 Hz	60 Hz	50 Hz	
	4	D301	Multi-speed setting (high speed) Simple	0 to 590 Hz	0.01 Hz	60 Hz	50 Hz	
	5	D302	Multi-speed setting (middle speed) Simple	0 to 590 Hz	0.01 Hz	30 Hz		
6	D303	Multi-speed setting (low speed) Simple	0 to 590 Hz	0.01 Hz	10 Hz			
DC injection brake	7	F010	Acceleration time Simple	0 to 3600 s	0.1 s	5 s*3		
						10 s		
	8	F011	Deceleration time Simple	0 to 3600 s	0.1 s	5 s*3		
						10 s		
—	9	H000 C103	Electronic thermal O/L relay Simple Rated motor current Simple	0 to 500 A	0.01 A	Inverter rated current		
	10	G100	DC injection brake operation frequency	0 to 120 Hz	0.01 Hz	3 Hz		
	11	G101	DC injection brake operation time	0 to 10 s, 9999	0.1 s	0.5 s		
—	12	G110	DC injection brake operation voltage	0% to 30%	0.1%	6%*4		
						4%*4		
						1%*4		
—	13	F102	Starting frequency	0 to 60 Hz	0.01 Hz	0.5 Hz		
—	14	G003	Load pattern selection	0 to 3	1	0		
JOG operation	15	D200	Jog frequency	0 to 590 Hz	0.01 Hz	5 Hz		
	16	F002	Jog acceleration/deceleration time	0 to 3600 s	0.1 s	0.5 s		
—	17	T720	MRS/X10 terminal input selection	0 to 5	1	0		
—	18	H402	High speed maximum frequency	0 to 590 Hz	0.01 Hz	120 Hz		
—	19	G002	Base frequency voltage	0 to 1000 V, 8888, 9999	0.1 V	9999	8888	
Acceleration/ deceleration time	20	F000	Acceleration/deceleration reference frequency	1 to 590 Hz	0.01 Hz	60 Hz	50 Hz	
	21	F001	Acceleration/deceleration time increments	0, 1	1	0		

Function	Pr.	Pr. group	Name	Setting range	Minimum setting increments	Initial value*1		Customer setting
						Gr.1	Gr.2	
Stall prevention	22	H500	Stall prevention operation level (Torque limit level)	0% to 400%	0.1%	150%		
	23	H610	Stall prevention operation level compensation factor at double speed	0% to 200%, 9999	0.1%	9999		
Multi-speed setting	24 to 27	D304 to D307	Multi-speed setting (speed 4 to speed 7)	0 to 590 Hz, 9999	0.01 Hz	9999		
—	29	F100	Acceleration/deceleration pattern selection	0 to 2	1	0		
—	30	E300	Regenerative function selection	0 to 2	1	0		
Frequency jump	31	H420	Frequency jump 1A	0 to 590 Hz, 9999	0.01 Hz	9999		
	32	H421	Frequency jump 1B	0 to 590 Hz, 9999	0.01 Hz	9999		
	33	H422	Frequency jump 2A	0 to 590 Hz, 9999	0.01 Hz	9999		
	34	H423	Frequency jump 2B	0 to 590 Hz, 9999	0.01 Hz	9999		
	35	H424	Frequency jump 3A	0 to 590 Hz, 9999	0.01 Hz	9999		
	36	H425	Frequency jump 3B	0 to 590 Hz, 9999	0.01 Hz	9999		
—	37	M000	Speed display	0.01 to 9998	0.001	1800		
—	40	E202	RUN key rotation direction selection	0, 1	1	0		
Frequency detection	41	M441	Up-to-frequency sensitivity	0% to 100%	0.1%	10%		
	42	M442	Output frequency detection	0 to 590 Hz	0.01 Hz	6 Hz		
	43	M443	Output frequency detection for reverse rotation	0 to 590 Hz, 9999	0.01 Hz	9999		
Second function	44	F020	Second acceleration/deceleration time	0 to 3600 s	0.1 s	5 s*3	10 s*3	
	45	F021	Second deceleration time	0 to 3600 s, 9999	0.1 s	9999		
	46	G010	Second torque boost	0% to 30%, 9999	0.1%	9999		
	47	G011	Second V/F (base frequency)	0 to 590 Hz, 9999	0.01 Hz	9999		
	48	H600	Second stall prevention operation level	0% to 400%, 9999	0.1%	9999		
	51	H010 C203	Second electronic thermal O/L relay Rated second motor current	0 to 500 A, 9999	0.01 A	9999		
Monitoring	52	M100	Operation panel main monitor selection	[E800][E800-EPB] 0, 5 to 12, 14, 17, 18, 20, 23 to 25, 32, 33, 38, 40 to 42, 44, 45, 50 to 57, 61, 62, 67, 91, 97, 100 [E800-EPA] 0, 5 to 12, 14, 17, 18, 20, 23 to 25, 32, 33, 38, 40 to 42, 44, 45, 50 to 57, 61, 62, 67, 83, 91, 97, 100	1	0		
	53	M003	Frequency / rotation speed unit switchover	0, 1, 4	1	0		
	54	M300	FM terminal function selection [E800-1]	1 to 3, 5 to 12, 14, 17, 18, 21, 24, 32, 33, 50, 52, 53, 61, 62, 67, 70, 97	1	1		
	55*5	M040	Frequency monitoring reference	0 to 590 Hz	0.01 Hz	60 Hz	50 Hz	
	56*5	M041	Current monitoring reference	0 to 500 A	0.01 A	Inverter rated current		
Automatic restart	57	A702	Restart coasting time	0, 0.1 to 30 s, 9999	0.1 s	9999		
	58	A703	Restart cushion time	0 to 60 s	0.1 s	1 s		
—	59	F101	Remote function selection	0 to 3, 11 to 13	1	0		
—	60	G030	Energy saving control selection	0, 9	1	0		
Automatic acceleration/deceleration	61	F510	Reference current	0 to 500 A, 9999	0.01 A	9999		
	62	F511	Reference value at acceleration	0% to 400%, 9999	1%	9999		
	63	F512	Reference value at deceleration	0% to 400%, 9999	1%	9999		
—	65	H300	Retry selection	0 to 5	1	0		
—	66	H611	Stall prevention operation reduction starting frequency	0 to 590 Hz	0.01 Hz	60 Hz	50 Hz	

Function	Pr.	Pr. group	Name	Setting range	Minimum setting increments	Initial value*1		Customer setting
						Gr.1	Gr.2	
Retry	67	H301	Number of retries at fault occurrence	0 to 10, 101 to 110	1	0		
	68	H302	Retry waiting time	0.1 to 600 s	0.1 s	1 s		
	69	H303	Retry count display erase	0	1	0		
—	70	G107	Special regenerative brake duty	0% to 100%	0.1%	0%		
—	71	C100	Applied motor	[200 V class / 400 V class] 0, 3, 5, 6, 10, 13, 15, 16, 20, 23, 40, 43, 50, 53, 70, 73, 8090, 8093, 9090, 9093 [575 V class] 0, 3, 5, 6, 10, 13, 15, 16, 8090, 8093, 9090, 9093	1	0		
—	72	E600	PWM frequency selection	0 to 15	1	1		
—	73	T000	Analog input selection	0, 1, 6, 10, 11, 16	1	1		
—	74	T002	Input filter time constant	0 to 8	1	1		
—	75	—	Reset selection/disconnected PU detection/PU stop selection	0 to 3, 14 to 17	1	14		
		E100	Reset selection	0, 1		0		
		E101	Disconnected PU detection			1		
		E102	PU stop selection					
—	77	E400	Parameter write selection	0 to 2	1	0		
—	78	D020	Reverse rotation prevention selection	0 to 2	1	0		
—	79	D000	Operation mode selection Simple	0 to 4, 6, 7	1	0		
Motor constant	80	C101	Motor capacity	0.1 to 30 kW, 9999	0.01 kW	9999		
	81	C102	Number of motor poles	2, 4, 6, 8, 10, 12, 9999	1	9999		
	82	C125	Motor excitation current	0 to 500 A, 9999	0.01 A	9999		
	83	C104	Rated motor voltage	0 to 1000 V	0.1 V	[200 V class] 200 V [400 V class] 400 V [575 V class] 575 V		
	84	C105	Rated motor frequency	10 to 400 Hz, 9999	0.01 Hz	9999		
	89	G932	Speed control gain (Advanced magnetic flux vector)	0% to 200%, 9999	0.1%	9999		
	90	C120	Motor constant (R1)	0 to 50 Ω, 9999	0.001Ω	9999		
	91	C121	Motor constant (R2)	0 to 50 Ω, 9999	0.001Ω	9999		
	92	C122	Motor constant (L1)/d-axis inductance (Ld)	0 to 6000 mH, 9999	0.1 mH	9999		
	93	C123	Motor constant (L2)/q-axis inductance (Lq)	0 to 6000 mH, 9999	0.1 mH	9999		
	94	C124	Motor constant (X)	0% to 100%, 9999	0.1%	9999		
95	C111	Online auto tuning selection	0, 1	1	0			
96	C110	Auto tuning setting/status	0, 1, 11	1	0			
PU connector communication	117	N020	PU communication station number	0 to 31	1	0		
	118	N021	PU communication speed	48, 96, 192, 384, 576, 768, 1152	1	192		
	119	—	PU communication stop bit length / data length	0, 1, 10, 11	1	1		
		N022	PU communication data length	0, 1		0		
		N023	PU communication stop bit length	0, 1		1		
	120	N024	PU communication parity check	0 to 2	1	2		
	121	N025	PU communication retry count	0 to 10, 9999	1	1		
	122	N026	PU communication check time interval	0, 0.1 to 999.8 s, 9999	0.1 s	0		
	123	N027	PU communication waiting time setting	0 to 150 ms, 9999	1 ms	9999		
124	N028	PU communication CR/LF selection	0 to 2	1	1			
—	125	T022	Terminal 2 frequency setting gain frequency Simple	0 to 590 Hz	0.01 Hz	60 Hz	50 Hz	
—	126	T042	Terminal 4 frequency setting gain frequency Simple	0 to 590 Hz	0.01 Hz	60 Hz	50 Hz	

Function	Pr.	Pr. group	Name	Setting range	Minimum setting increments	Initial value*1		Customer setting	
						Gr.1	Gr.2		
PID operation	127	A612	PID control automatic switchover frequency	0 to 590 Hz, 9999	0.01 Hz	9999			
	128	A610	PID action selection	0, 20, 21, 40 to 43, 50, 51, 60, 61, 1000, 1001, 1010, 1011, 2000, 2001, 2010, 2011	1	0			
	129	A613	PID proportional band	0.1% to 1000%, 9999	0.1%	100%			
	130	A614	PID integral time	0.1 to 3600 s, 9999	0.1 s	1 s			
	131	A601	PID upper limit	0% to 100%, 9999	0.1%	9999			
	132	A602	PID lower limit	0% to 100%, 9999	0.1%	9999			
	133	A611	PID action set point	0% to 100%, 9999	0.01%	9999			
—	134	A615	PID differential time	0.01 to 10 s, 9999	0.01 s	9999			
—	145	E103	Parameter for manufacturer setting. Do not set.						
—	147	F022	Acceleration/deceleration time switching frequency	0 to 590 Hz, 9999	0.01 Hz	9999			
Current detection	150	M460	Output current detection level	0% to 400%	0.1%	150%			
	151	M461	Output current detection signal delay time	0 to 10 s	0.1 s	0 s			
	152	M462	Zero current detection level	0% to 400%	0.1%	5%			
	153	M463	Zero current detection time	0 to 10 s	0.01 s	0.5 s			
—	154	H631	Voltage reduction selection during stall prevention operation	1, 11	1	1			
—	156	H501	Stall prevention operation selection	0 to 31, 100, 101	1	0			
—	157	M430	OL signal output timer	0 to 25 s, 9999	0.1 s	0 s			
—	158	M301	AM terminal function selection [E800-4][E800-5]	1 to 3, 5 to 12, 14, 17, 18, 21, 24, 32, 33, 50, 52 to 54, 61, 62, 67, 70, 91, 97	1	1			
—	160	E440	User group read selection <i>Simple</i>	0, 1, 9999	1	0			
—	161	E200	Frequency setting/key lock operation selection	0, 1, 10, 11	1	0			
Automatic restart	162	A700	Automatic restart after instantaneous power failure selection	0, 1, 10, 11	1	0			
	165	A710	Stall prevention operation level for restart	0% to 400%	0.1%	150%			
Current detection	166	M433	Output current detection signal retention time	0 to 10 s, 9999	0.1 s	0.1 s			
	167	M464	Output current detection operation selection	0, 1, 10, 11	1	0			
—	168	E000	Parameter for manufacturer setting. Do not set.						
—		E080							
—	169	E001							
—		E081							
Cumulative monitor	170	M020	Watt-hour meter clear	0, 10, 9999	1	9999			
	171	M030	Operation hour meter clear	0, 9999	1	9999			
User group	172	E441	User group registered display/batch clear	9999, (0 to 16)	1	0			
	173	E442	User group registration	0 to 1999, 9999	1	9999			
	174	E443	User group clear	0 to 1999, 9999	1	9999			

Function	Pr.	Pr. group	Name	Setting range	Minimum setting increments	Initial value*1		Customer setting
						Gr.1	Gr.2	
Input terminal function assignment	178	T700	STF/DI0 terminal function selection	0 to 5, 7, 8, 10, 12, 14 to 16, 18, 24 to 27, 30, 37, 46, 47, 50, 51, 60, 62, 65 to 67, 72, 92, 9999	1	60		
	179	T701	STR/DI1 terminal function selection	0 to 5, 7, 8, 10, 12, 14 to 16, 18, 24 to 27, 30, 37, 46, 47, 50, 51, 61, 62, 65 to 67, 72, 92, 9999	1	61		
	180	T702	RL terminal function selection		1	0		
	181	T703	RM terminal function selection	[E800] 0 to 5, 7, 8, 10, 12, 14 to 16, 18, 24 to 27, 30, 37, 46, 47, 50, 51, 62, 65 to 67, 72, 92, 9999	1	1		
	182	T704	RH terminal function selection		1	2		
	183	T709	MRS terminal function selection	[E800-E] 0 to 4, 8, 14, 15, 18, 24, 26, 27, 30, 37, 46, 47, 50, 51, 72, 92, 9999	1	24		
	184	T711	RES terminal function selection		1	[E800] 62 [E800-E] 9999		
	185	T751	NET X1 input selection		1			
	186	T752	NET X2 input selection		1			
	187	T753	NET X3 input selection	0 to 4, 8, 14, 15, 18, 24, 26, 27, 30, 37, 46, 47, 50, 51, 72, 92, 9999	1	9999		
188	T754	NET X4 input selection		1				
189	T755	NET X5 input selection		1				
Output terminal function assignment	190	M400	RUN terminal function selection	0, 1, 3, 4, 7, 8, 11 to 16, 20, 25, 26, 34, 35, 39 to 41, 44 to 48, 57, 64, 70, 80, 81, 90 to 93, 95, 96, 98, 99, 100, 101, 103, 104, 107, 108, 111 to 116, 120, 125, 126, 134, 135, 139 to 141, 144 to 148, 157, 164, 170, 180, 181, 190 to 193, 195, 196, 198, 199, 206, 211 to 213, 242 [E800-E], 306, 311 to 313, 342 [E800-E]	1	0		
	191	M404	FU terminal function selection		1	4		
	192	M405	ABC terminal function selection	0, 1, 3, 4, 7, 8, 11 to 16, 20, 25, 26, 34, 35, 39, 40, 41, 44 to 48, 57, 64, 70, 80, 81, 82 [E800-EPA], 90, 91, 95, 96, 98, 99, 100, 101, 103, 104, 107, 108, 111 to 116, 120, 125, 126, 134, 135, 139, 140, 141, 144 to 148, 157, 164, 170, 180, 181, 182 [E800-EPA], 190, 191, 195, 196, 198, 199, 206, 211 to 213, 242 [E800-E], 306, 311 to 313, 342 [E800-E]	1	99		
	193	M451	NET Y1 output selection	0, 1, 3, 4, 7, 8, 11 to 16, 20, 25, 26, 34, 35, 39 to 41, 44 to 48, 57, 64, 70, 80, 81, 90 to 93, 95, 98, 99, 100, 101, 103, 104, 107, 108, 111 to 116, 120, 125, 126, 134, 135, 139 to 141, 144 to 148, 157, 164, 170, 180, 181, 190 to 193, 195, 198, 199, 206, 211 to 213, 242 [E800-E], 306, 311 to 313, 342 [E800-E]	1	9999		
	194	M452	NET Y2 output selection		1	9999		
	195	M453	NET Y3 output selection		1	9999		
	196	M454	NET Y4 output selection		1	9999		
—	198	E709	Display corrosion level	(1 to 3)	1	1		
Multi-speed setting	232 to 239	D308 to D315	Multi-speed setting (speed 8 to speed 15)	0 to 590 Hz, 9999	0.01 Hz	9999		
—	240	E601	Soft-PWM operation selection	0, 1	1	1		
—	241	M043	Analog input display unit switchover	0, 1	1	0		
—	244	H100	Cooling fan operation selection	0, 1	1	1		

Function	Pr.	Pr. group	Name	Setting range	Minimum setting increments	Initial value*1		Customer setting	
						Gr.1	Gr.2		
Slip compensation	245	G203	Rated slip	0% to 50%, 9999	0.01%	9999			
	246	G204	Slip compensation time constant	0.01 to 10 s	0.01 s	0.5 s			
	247	G205	Constant output range slip compensation selection	0, 9999	1	9999			
—	249	H101	Earth (ground) fault detection at start	0, 1	1	0	1		
—	250	G106	Stop selection	0 to 100 s, 1000 to 1100 s, 8888, 9999	0.1 s	9999			
—	251	H200	Output phase loss protection selection	0, 1	1	1			
Life check	255	E700	Life alarm status display	(0 to 879)	1	0			
	256	E701	Inrush current limit circuit life display	(0% to 100%)	1%	100%			
	257	E702	Control circuit capacitor life display	(0% to 100%)	1%	100%			
	258	E703	Main circuit capacitor life display	(0% to 100%)	1%	100%			
	259	E704	Main circuit capacitor life measuring	0, 1	1	0			
—	260	E602	PWM frequency automatic switchover	0, 10	1	10			
Power failure stop	261	A730	Power failure stop selection	0 to 2	1	0			
	—	267	T001	Terminal 4 input selection	0 to 2	1	0		
	—	268	M022	Monitor decimal digits selection	0, 1, 9999	1	9999		
—	269	E023	Parameter for manufacturer setting. Do not set.						
Stop-on-contact control	270	A200	Stop-on-contact control selection	0, 1, 11	1	0			
	275	A205	Stop-on contact excitation current low-speed scaling factor	0% to 300%, 9999	0.1%	9999			
	276	A206	PWM carrier frequency at stop-on contact	0 to 9, 9999	1	9999			
	277	H630	Stall prevention operation current switchover	0, 1	1	0			
Brake sequence	278	A100	Brake opening frequency	0 to 30 Hz	0.01 Hz	3 Hz			
	279	A101	Brake opening current	0% to 400%	0.1%	130%			
	280	A102	Brake opening current detection time	0 to 2 s	0.1 s	0.3 s			
	281	A103	Brake operation time at start	0 to 5 s	0.1 s	0.3 s			
	282	A104	Brake operation frequency	0 to 30 Hz	0.01 Hz	6 Hz			
	283	A105	Brake operation time at stop	0 to 5 s	0.1 s	0.3 s			
—	285	H416	Speed deviation excess detection frequency	0 to 30 Hz, 9999	0.01 Hz	9999			
Droop control	286	G400	Droop gain	0% to 100%	0.1%	0%			
	287	G401	Droop filter time constant	0 to 1 s	0.01 s	0.3 s			
—	289	M431	Inverter output terminal filter	5 to 50 ms, 9999	1 ms	9999			
—	290	M044	Monitor negative output selection	0, 1, 4, 5, 8, 9, 12, 13	1	0			
—	292	A110 F500	Automatic acceleration/deceleration	0, 1, 7, 8, 11	1	0			
—	293	F513	Acceleration/deceleration separate selection	0 to 2	1	0			
—	295	E201	Frequency change increment amount setting	0, 0.01, 0.1, 1, 10,	0.01	0			
Password	296	E410	Password lock level	0 to 6, 99, 100 to 106, 199, 9999	1	9999			
	297	E411	Password lock/unlock	(0 to 5), 1000 to 9998, 9999	1	9999			
—	298	A711	Frequency search gain	0 to 32767, 9999	1	9999			
—	299	A701	Rotation direction detection selection at restarting	0, 1, 9999	1	0			

Function	Pr.	Pr. group	Name	Setting range	Minimum setting increments	Initial value*1		Customer setting
						Gr.1	Gr.2	
CC-Link IE	313*6	M410	DO0 output selection	0, 1, 3, 4, 7, 8, 11 to 16, 20, 25, 26, 34, 35, 39 to 41, 44 to 48, 57, 64, 70, 80, 81, 90 to 93, 95, 96, 98, 99, 100, 101, 103, 104, 107, 108, 111 to 116, 120, 125, 126, 134, 135, 139 to 141, 144 to 148, 157, 164, 170, 180, 181, 190 to 193, 195, 196, 198, 199, 206, 211 to 213, 242 [E800-E], 306, 311 to 313, 342 [E800-E], 9999	1	9999		
	314*6	M411	DO1 output selection		1	9999		
	315*6	M412	DO2 output selection		1	9999		
	316*6	M413	DO3 output selection		1	9999		
	317*6	M414	DO4 output selection		1	9999		
	318*6	M415	DO5 output selection		1	9999		
	319*6	M416	DO6 output selection		1	9999		
	320*6	M420	RA1 output selection		1	0		
	321*6	M421	RA2 output selection		1	1		
	322*6	M422	RA3 output selection		1	4		
RS-485 communication	338	D010	Communication operation command source	0, 1	1	0		
	339	D011	Communication speed command source	0 to 2	1	0		
	340	D001	Communication startup mode selection	0, 1, 10	1	[E800] 0 [E800-E] 10		
	342	N001	Communication EEPROM write selection	0, 1	1	0		
	343	N080	Communication error count	(0 to 999)	1	0		
—	349*7	N010	Communication reset selection	0, 1	1	0		
—	374	H800	Overspeed detection level	0 to 590 Hz, 9999	0.01 Hz	9999		
—	390	N054	% setting reference frequency	1 to 590 Hz	0.01 Hz	60 Hz	50 Hz	
PLC	414	A800	PLC function operation selection	0 to 2, 11, 12	1	0		
	415	A801	Inverter operation lock mode setting	0, 1	1	0		
Ethernet	442	N620	Default gateway address 1 [E800-E]	0 to 255	1	0		
	443	N621	Default gateway address 2 [E800-E]					
	444	N622	Default gateway address 3 [E800-E]					
	445	N623	Default gateway address 4 [E800-E]					
Second motor constant	450	C200	Second applied motor	[200 V class / 400 V class] 0, 3, 5, 6, 10, 13, 15, 16, 20, 23, 40, 43, 50, 53, 70, 73, 8090, 8093, 9090, 9093 [575 V class] 0, 3, 5, 6, 10, 13, 15, 16, 8090, 8093, 9090, 9093	1	9999		
	451	G300	Second motor control method selection	10 to 12, 20, 40, 9999	1	9999		
	453	C201	Second motor capacity	0.1 to 30 kW, 9999	0.01 kW	9999		
	454	C202	Number of second motor poles	2, 4, 6, 8, 10, 12, 9999	1	9999		
	455	C225	Second motor excitation current	0 to 500 A, 9999	0.01 A	9999		
	456	C204	Rated second motor voltage	0 to 1000 V	0.1 V	[200 V class] 200 V [400 V class] 400 V [575 V class] 575 V		
	457	C205	Rated second motor frequency	10 to 400 Hz, 9999	0.01 Hz	9999		
	458	C220	Second motor constant (R1)	0 to 50 Ω, 9999	0.001 Ω	9999		
	459	C221	Second motor constant (R2)	0 to 50 Ω, 9999	0.001 Ω	9999		
	460	C222	Second motor constant (L1) / d-axis inductance (Ld)	0 to 6000 mH, 9999	0.1 mH	9999		
	461	C223	Second motor constant (L2) / q-axis inductance (Lq)	0 to 6000 mH, 9999	0.1 mH	9999		
	462	C224	Second motor constant (X)	0% to 100%, 9999	0.1%	9999		
	463	C210	Second motor auto tuning setting/status	0, 1, 11	1	0		

Function	Pr.	Pr. group	Name	Setting range	Minimum setting increments	Initial value*1		Customer setting
						Gr.1	Gr.2	
Remote output	495	M500	Remote output selection	0, 1, 10, 11	1	0		
	496	M501	Remote output data 1	0 to 4095	1	0		
	497	M502	Remote output data 2	0 to 4095	1	0		
—	498	A804	PLC function flash memory clear	0, 9696 (0 to 9999)	1	0		
—	502	N013	Stop mode selection at communication error	0 to 2, 6	1	0		
Maintenance	503	E710	Maintenance timer	0 (0 to 9998)	1	0		
	504	E711	Maintenance timer warning output set time	0 to 9998, 9999	1	9999		
—	505	M001	Speed setting reference	1 to 590 Hz	0.01 Hz	60 Hz	50 Hz	
Life check	506	E705	Display estimated main circuit capacitor residual life	(0% to 100%)	1%	100%		
	507	E706	Display ABC relay contact life	0% to 100%	1%	100%		
	509	E708	Display power cycle life	(0% to 100%)	0.01%	100%		
Communication	541	N100	Frequency command sign selection [E800-E]	0, 1	1	0		
	544	N103	CC-Link extended setting [E800-E]	0, 1, 12, 14, 18, 100, 112, 114, 118	1	0		
USB	547	N040	USB communication station number	0 to 31	1	0		
	548	N041	USB communication check time interval	0 to 999.8 s, 9999	0.1 s	9999		
Communication	549	N000	Protocol selection	0, 1	1	0		
	550	D012	NET mode operation command source selection	[E800] 0, 2, 9999 [E800-E] 0, 5, 9999	1	9999		
	551	D013	PU mode operation command source selection	[E800] 2 to 4, 9999 [E800-E] 3, 4, 9999	1	9999		
PID control	553	A603	PID deviation limit	0% to 100%, 9999	0.1%	9999		
	554	A604	PID signal operation selection	0 to 3, 10 to 13	1	0		
Average current monitoring	555	E720	Current average time	0.1 to 1 s	0.1 s	1 s		
	556	E721	Data output mask time	0 to 20 s	0.1 s	0 s		
	557	E722	Current average value monitor signal output reference current	0 to 500 A	0.01 A	Inverter rated current		
—	560	A712	Second frequency search gain	0 to 32767, 9999	1	9999		
—	563	M021	Energization time carrying-over times	(0 to 65535)	1	0		
—	564	M031	Operating time carrying-over times	(0 to 65535)	1	0		
Second motor constant	569	G942	Second motor speed control gain	0% to 200%, 9999	0.1%	9999		
Multiple rating	570	E301	Multiple rating setting	1, 2	1	2		
—	571	F103	Holding time at a start	0 to 10 s, 9999	0.1 s	9999		
—	574	C211	Second motor online auto tuning	0, 1	1	0		
PID control	575	A621	Output interruption detection time	0 to 3600 s, 9999	0.1 s	1 s		
	576	A622	Output interruption detection level	0 to 590 Hz	0.01 Hz	0 Hz		
	577	A623	Output interruption cancel level	900% to 1100%	0.1%	1000%		
Traverse	592	A300	Traverse function selection	0 to 2	1	0		
	593	A301	Maximum amplitude amount	0% to 25%	0.1%	10%		
	594	A302	Amplitude compensation amount during deceleration	0% to 50%	0.1%	10%		
	595	A303	Amplitude compensation amount during acceleration	0% to 50%	0.1%	10%		
	596	A304	Amplitude acceleration time	0.1 to 3600 s	0.1 s	5 s		
	597	A305	Amplitude deceleration time	0.1 to 3600 s	0.1 s	5 s		

Function	Pr.	Pr. group	Name	Setting range	Minimum setting increments	Initial value*1		Customer setting
						Gr.1	Gr.2	
PID control	609	A624	PID set point/deviation input selection	2 to 5	1	2		
	610	A625	PID measured value input selection	2 to 5	1	3		
—	611	F003	Acceleration time at a restart	0 to 3600 s, 9999	0.1 s	9999		
—	631	H182	Inverter output fault detection enable/disable selection	0, 1	1	0		
Brake sequence	639	A108	Brake opening current selection	0, 1	1	0		
	640	A109	Brake operation frequency selection	0, 1	1	0		
Speed smoothing control	653	G410	Speed smoothing control	0% to 200%	0.1%	0%		
	654	G411	Speed smoothing cutoff frequency	0 to 120 Hz	0.01 Hz	20 Hz		
—	665	G125	Regeneration avoidance frequency gain	0% to 200%	0.1%	100%		
—	673	G060	SF-PR slip amount adjustment operation selection [200 V class / 400 V class]	2, 4, 6, 9999	1	9999		
—	674	G061	SF-PR slip amount adjustment gain [200 V class / 400 V class]	0% to 500%	0.1%	100%		
—	675	A805	User parameter auto storage function selection	1, 9999	1	9999		
—	699	T740	Input terminal filter	5 to 50 ms, 9999	1 ms	9999		
Motor constant	702	C106	Maximum motor frequency	0 to 400 Hz, 9999	0.01 Hz	9999		
	706	C130	Induced voltage constant (phi f)	0 to 5000 mV (rad/s), 9999	0.1 mV (rad/s)	9999		
	707	C107	Motor inertia (integer)	10 to 999, 9999	1	9999		
	711	C131	Motor Ld decay ratio	0% to 100%, 9999	0.1%	9999		
	712	C132	Motor Lq decay ratio	0% to 100%, 9999	0.1%	9999		
	717	C182	Starting resistance tuning compensation coefficient 1	0% to 200%, 9999	0.1%	9999		
	720	C188	Starting resistance tuning compensation coefficient	0% to 200%, 9999	0.1%	9999		
	721	C185	Starting magnetic pole position detection pulse width	0 to 6000 μs, 9999	1 μs	9999		
	724	C108	Motor inertia (exponent)	0 to 7, 9999	1	9999		
	725	C133	Motor protection current level	100% to 500%, 9999	0.1%	9999		
Ethernet	728	N052	Device instance number (Upper 3 digits) [E800-EPA]	0 to 419	1	0		
	729	N053	Device instance number (Lower 4 digits) [E800-EPA]	0 to 9999	1	0		
Motor constant	737	C288	Starting resistance tuning compensation coefficient 2	0% to 200%, 9999	0.1%	9999		
	738	C230	Second motor induced voltage constant (phi f)	0 to 5000 mV (rad/s), 9999	0.1 mV (rad/s)	9999		
	739	C231	Second motor Ld decay ratio	0% to 100%, 9999	0.1%	9999		
	740	C232	Second motor Lq decay ratio	0% to 100%, 9999	0.1%	9999		
	741	C282	Second motor starting resistance tuning compensation coefficient 1	0% to 200%, 9999	0.1%	9999		
	742	C285	Second motor magnetic pole detection pulse width	0 to 6000 μs, 9999	1 μs	9999		
	743	C206	Second motor maximum frequency	0 to 400 Hz, 9999	0.01 Hz	9999		
	744	C207	Second motor inertia (integer)	10 to 999, 9999	1	9999		
	745	C208	Second motor inertia (exponent)	0 to 7, 9999	1	9999		
	746	C233	Second motor protection current level	100% to 500%, 9999	0.1%	9999		
—	759	A600	Parameter for manufacturer setting. Do not set.					

Function	Pr.	Pr. group	Name	Setting range	Minimum setting increments	Initial value*1		Customer setting
						Gr.1	Gr.2	
Monitoring	774	M101	Operation panel monitor selection 1	[E800][E800-EPB] 1 to 3, 5 to 12, 14, 17, 18, 20, 23 to 25, 32, 33, 38, 40 to 42, 44, 45, 50 to 57, 61, 62, 67, 91, 97, 100, 9999	1	9999		
	775	M102	Operation panel monitor selection 2	[E800-EPA] 1 to 3, 5 to 12, 14, 17, 18, 20, 23 to 25, 32, 33, 38, 40 to 42, 44, 45, 50 to 57, 61, 62, 67, 83, 91, 97, 100, 9999	1	9999		
	776	M103	Operation panel monitor selection 3		1	9999		
—	779	N014	Operation frequency during communication error	0 to 590 Hz, 9999	0.01 Hz	9999		
—	791	F070	Acceleration time in low-speed range	0 to 3600 s, 9999	0.1 s	9999		
—	792	F071	Deceleration time in low-speed range	0 to 3600 s, 9999	0.1 s	9999		
—	800	G200	Control method selection	10 to 12, 19, 20, 40	1	40		
—	801	H704	Output limit level	0% to 400%, 9999	0.1%	9999		
Torque command	803	G210	Constant output range torque characteristic selection	0 to 2, 10	1	0		
	804	D400	Torque command source selection	0, 1, 3 to 6	1	0		
	805	D401	Torque command value (RAM)	600% to 1400%	1%	1000%		
	806	D402	Torque command value (RAM, EEPROM)	600% to 1400%	1%	1000%		
Speed limit	807	H410	Speed limit selection	0, 1	1	0		
	808	H411	Speed limit	0 to 400 Hz	0.01 Hz	60 Hz	50 Hz	
	809	H412	Reverse-side speed limit	0 to 400 Hz, 9999	0.01 Hz	9999		
Torque limit	810	H700	Torque limit input method selection	0 to 2	1	0		
	811	D030	Set resolution switchover	0, 10	1	0		
	812	H701	Torque limit level (regeneration)	0% to 400%, 9999	0.1%	9999		
	813	H702	Torque limit level (3rd quadrant)	0% to 400%, 9999	0.1%	9999		
	814	H703	Torque limit level (4th quadrant)	0% to 400%, 9999	0.1%	9999		
	815	H710	Torque limit level 2	0% to 400%, 9999	0.1%	9999		
	816	H720	Torque limit level during acceleration	0% to 400%, 9999	0.1%	9999		
Adjustment	820	G211	Speed control P gain 1	0% to 1000%	1%	60%		
	821	G212	Speed control integral time 1	0 to 20 s	0.001 s	0.333 s		
	822	T003	Speed setting filter 1	0 to 5 s, 9999	0.001 s	9999		
	824	G213	Torque control P gain 1 (current loop proportional gain)	0% to 500%	1%	100%		
	825	G214	Torque control integral time 1 (current loop integral time)	0 to 500 ms	0.1 ms	5 ms		
	826	T004	Torque setting filter 1	0 to 5 s, 9999	0.001 s	9999		
	830	G311	Speed control P gain 2	0% to 1000%, 9999	1%	9999		
	831	G312	Speed control integral time 2	0 to 20 s, 9999	0.001 s	9999		
	832	T005	Speed setting filter 2	0 to 5 s, 9999	0.001 s	9999		
	834	G313	Torque control P gain 2 (current loop proportional gain)	0% to 500%, 9999	1%	9999		
	835	G314	Torque control integral time 2 (current loop integral time)	0 to 500 ms, 9999	0.1 ms	9999		
Additional function	849	T007	Analog input offset adjustment	0% to 200%	0.1%	100%		
	850	G103	Brake operation selection	0, 1	1	0		
	853	H417	Speed deviation time	0 to 100 s	0.1 s	1 s		
	858	T040	Terminal 4 function assignment	0, 4, 9999	1	0		
	859	C126	Torque current/Rated PM motor current	0 to 500 A, 9999	0.01 A	9999		
	860	C226	Second motor torque current/Rated PM motor current	0 to 500 A, 9999	0.01 A	9999		
	864	M470	Torque detection	0% to 400%	0.1%	150%		
	865	M446	Low speed detection	0 to 590 Hz	0.01 Hz	1.5 Hz		

Function	Pr.	Pr. group	Name	Setting range	Minimum setting increments	Initial value*1		Customer setting	
						Gr.1	Gr.2		
Indication	866	M042	Torque monitoring reference	0% to 400%	0.1%	150%			
	867	M321	AM output filter [E800-4][E800-5]	0 to 5 s	0.01 s	0.01 s			
—	870	M440	Speed detection hysteresis	0 to 15 Hz	0.01 Hz	0 Hz			
Protective function	872	H201	Input phase loss protection selection	0, 1	1	1			
	874	H730	OLT level setting	0% to 400%	0.1%	150%			
Regeneration avoidance	882	G120	Regeneration avoidance operation selection	0 to 2	1	0			
	883	G121	Regeneration avoidance operation level	300 to 1200 V	0.1 V	[200 V class] 400 V [400 V class] 780 V [575 V class] 944 V			
	885	G123	Regeneration avoidance compensation frequency limit value	0 to 45 Hz, 9999	0.01 Hz	6 Hz			
	886	G124	Regeneration avoidance voltage gain	0% to 200%	0.1%	100%			
Free parameter	888	E420	Free parameter 1	0 to 9999	1	9999			
	889	E421	Free parameter 2	0 to 9999	1	9999			
Energy saving monitoring	891	M023	Cumulative power monitor digit shifted times	0 to 4, 9999	1	9999			
	892	M200	Load factor	30% to 150%	0.1%	100%			
	893	M201	Energy saving monitor reference (motor capacity)	0.1 to 30 kW	0.01 kW	Inverter rated capacity			
	894	M202	Control selection during commercial power-supply operation	0 to 3	1	0			
	895	M203	Power saving rate reference value	0, 1, 9999	1	9999			
	896	M204	Power unit cost	0 to 500, 9999	0.01	9999			
	897	M205	Power saving monitor average time	0 to 1000 h, 9999	1 h	9999			
	898	M206	Power saving cumulative monitor clear	0, 1, 10, 9999	1	9999			
	899	M207	Operation time rate (estimated value)	0% to 100%, 9999	0.1%	9999			
Calibration parameter	C0	M310	FM terminal calibration [E800-1]	—	—	—			
	C1	M320	AM terminal calibration [E800-4][E800-5]	—	—	—			
	C2	T200	Terminal 2 frequency setting bias frequency	0 to 590 Hz	0.01 Hz	0 Hz			
	C3	T201	Terminal 2 frequency setting bias	0% to 300%	0.1%	0%			
	125	T202	Terminal 2 frequency setting gain frequency	0 to 590 Hz	0.01 Hz	60 Hz	50 Hz		
	C4	T203	Terminal 2 frequency setting gain	0% to 300%	0.1%	100%			
	C5	T400	Terminal 4 frequency setting bias frequency	0 to 590 Hz	0.01 Hz	0 Hz			
	C6	T401	Terminal 4 frequency setting bias	0% to 300%	0.1%	20%			
	126	T402	Terminal 4 frequency setting gain frequency	0 to 590 Hz	0.01 Hz	60 Hz	50 Hz		
	C7	T403	Terminal 4 frequency setting gain	0% to 300%	0.1%	100%			
	C38	T410	Terminal 4 bias command (torque/magnetic flux)	0% to 400%	0.1%	0%			
	C39	T411	Terminal 4 bias (torque/magnetic flux)	0% to 300%	0.1%	20%			
	C40	T412	Terminal 4 gain command (torque/magnetic flux)	0% to 400%	0.1%	150%			
PID display	C41	T413	Terminal 4 gain (torque/magnetic flux)	0% to 300%	0.1%	100%			
	C42	A630	PID display bias coefficient	0 to 500, 9999	0.01	9999			
	C43	A631	PID display bias analog value	0% to 300%	0.1%	20%			
	C44	A632	PID display gain coefficient	0 to 500, 9999	0.01	9999			
	C45	A633	PID display gain analog value	0% to 300%	0.1%	100%			
—	990	E104	Parameter for manufacturer setting. Do not set.						
	991	E105							
Monitoring	992	M104	Operation panel setting dial push monitor selection	0 to 3, 5 to 12, 14, 17, 18, 20, 23 to 25, 32, 33, 38, 40 to 42, 44, 45, 50 to 57, 61, 62, 67, 91, 97, 100	1	0			

Function	Pr.	Pr. group	Name	Setting range	Minimum setting increments	Initial value*1		Customer setting	
						Gr.1	Gr.2		
—	997	H103	Fault initiation	0 to 255, 9999	1	9999			
—	998	E430	PM parameter initialization Simple	0, 8009, 8109, 9009, 9109,	1	0			
—	999	E431	Automatic parameter setting Simple	10, 12, 20, 21, 9999	1	9999			
—	1000	E108	Parameter for manufacturer setting. Do not set.						
—	1002	C150	Lq tuning target current adjustment coefficient	50% to 150%, 9999	0.1%	9999			
Clock	1006	E020	Clock (year)	2000 to 2099	1	2000			
	1007	E021	Clock (month, day)	Jan. 1 to Dec. 31	1	101			
	1008	E022	Clock (hour, minute)	0:00 to 23:59	1	0			
—	1015	A607	Integral stop selection at limited frequency	0 to 2	1	0			
Trace	1020	A900	Trace operation selection	0 to 3	1	0			
	1022	A902	Sampling cycle	1, 2, 5, 10, 50, 100, 500, 1000	1	1			
	1023	A903	Number of analog channels	1 to 8	1	4			
	1024	A904	Sampling auto start	0, 1	1	0			
	1025	A905	Trigger mode selection	0 to 4	1	0			
	1026	A906	Number of sampling before trigger	0% to 100%	1%	90%			
	1027	A910	Analog source selection (1ch)	1 to 3, 5 to 12, 14, 17, 18, 20, 23, 24, 32, 33, 40 to 42, 52 to 54, 61, 62, 67, 83 [E800-EPA], 91, 97, 201 to 210, 212, 213, 230 to 232, 235 to 238	1	201			
	1028	A911	Analog source selection (2ch)			202			
	1029	A912	Analog source selection (3ch)			203			
	1030	A913	Analog source selection (4ch)			204			
	1031	A914	Analog source selection (5ch)			205			
	1032	A915	Analog source selection (6ch)			206			
	1033	A916	Analog source selection (7ch)			207			
	1034	A917	Analog source selection (8ch)			208			
	1035	A918	Analog trigger channel	1 to 8	1	1			
	1036	A919	Analog trigger operation selection	0, 1	1	0			
	1037	A920	Analog trigger level	600 to 1400	1	1000			
	1038	A930	Digital source selection (1ch)	0 to 255	1	0			
	1039	A931	Digital source selection (2ch)			0			
	1040	A932	Digital source selection (3ch)			0			
1041	A933	Digital source selection (4ch)	0						
1042	A934	Digital source selection (5ch)	0						
1043	A935	Digital source selection (6ch)	0						
1044	A936	Digital source selection (7ch)	0						
1045	A937	Digital source selection (8ch)	0						
1046	A938	Digital trigger channel	1 to 8	1	1				
1047	A939	Digital trigger operation selection	0, 1	1	0				
—	1103	F040	Deceleration time at emergency stop	0 to 3600 s	0.1 s	5 s			
Monitoring	1106	M050	Torque monitor filter	0 to 5 s, 9999	0.01 s	9999			
	1107	M051	Running speed monitor filter	0 to 5 s, 9999	0.01 s	9999			
	1108	M052	Excitation current monitor filter	0 to 5 s, 9999	0.01 s	9999			
—	1124	N681	Station number in inverter-to-inverter link [E800-E]	0 to 5, 9999	1	9999			
—	1125	N682	Number of inverters in inverter-to-inverter link system [E800-E]	2 to 6	1	2			
PLC function	1150 to 1199	A810 to A859	PLC function user parameters 1 to 50	0 to 65535	1	0			
—	1200	M390	AM output offset calibration [E800-4][E800-5]	2700 to 3300	1	3000			
—	1399	N649	Inverter identification enable/disable selection [E800-E]	0, 1	1	1			
—	1412	C135	Motor induced voltage constant (phi f) exponent	0 to 2, 9999	1	9999			
—	1413	C235	Second motor induced voltage constant (phi f) exponent	0 to 2, 9999	1	9999			

Function	Pr.	Pr. group	Name	Setting range	Minimum setting increments	Initial value*1		Customer setting
						Gr.1	Gr.2	
Ethernet function selection	1424	N650	Ethernet communication network number	1 to 239	1	1		
	1425	N651	Ethernet communication station number	1 to 120	1	1		
	1426	N641	Link speed and duplex mode selection	0 to 4	1	0		
	1427	N630	Ethernet function selection 1	[E800-EPA] 502, 5000 to 5002, 5006 to 5008, 5010 to 5013, 44818, 45237, 45238, 47808, 61450, 9999	1	5001		
	1428	N631	Ethernet function selection 2	[E800-EPB] 502, 5000 to 5002, 5006 to 5008, 5010 to 5013, 34962, 45237, 45238, 61450, 9999	1	45237		
	1429	N632	Ethernet function selection 3	[E800-EPB] 502, 5000 to 5002, 5006 to 5008, 5010 to 5013, 34962, 45237, 45238, 61450, 9999	1	45238		
	1430	N633	Ethernet function selection 4	[E800-EPB] 502, 5000 to 5002, 5006 to 5008, 5010 to 5013, 34962, 45237, 45238, 61450, 9999	1	9999		
	1431	N643	Ethernet signal loss detection function selection	0 to 3	1	3		
	1432	N644	Ethernet communication check time interval	0 to 999.8 s, 9999	0.1 s	1.5		
Ethernet	1434	N600	Ethernet IP address 1	0 to 255	1	192		
	1435	N601	Ethernet IP address 2	0 to 255	1	168		
	1436	N602	Ethernet IP address 3	0 to 255	1	50		
	1437	N603	Ethernet IP address 4	0 to 255	1	1		
	1438	N610	Subnet mask 1	0 to 255	1	255		
	1439	N611	Subnet mask 2	0 to 255	1	255		
	1440	N612	Subnet mask 3	0 to 255	1	255		
	1441	N613	Subnet mask 4	0 to 255	1	0		
	1442	N660	Ethernet IP filter address 1	0 to 255	1	0		
	1443	N661	Ethernet IP filter address 2	0 to 255	1	0		
	1444	N662	Ethernet IP filter address 3	0 to 255	1	0		
	1445	N663	Ethernet IP filter address 4	0 to 255	1	0		
	1446	N664	Ethernet IP filter address 2 range specification	0 to 255, 9999	1	9999		
	1447	N665	Ethernet IP filter address 3 range specification	0 to 255, 9999	1	9999		
	1448	N666	Ethernet IP filter address 4 range specification	0 to 255, 9999	1	9999		
	1449	N670	Ethernet command source selection IP address 1	0 to 255	1	0		
	1450	N671	Ethernet command source selection IP address 2	0 to 255	1	0		
	1451	N672	Ethernet command source selection IP address 3	0 to 255	1	0		
	1452	N673	Ethernet command source selection IP address 4	0 to 255	1	0		
	1453	N674	Ethernet command source selection IP address 3 range specification	0 to 255, 9999	1	9999		
1454	N675	Ethernet command source selection IP address 4 range specification	0 to 255, 9999	1	9999			
1455	N642	Keepalive time	1 to 7200 s	1	60 s			
1456	N647	Network diagnosis selection	0 to 2, 9999	1	9999			
1457	N648	Extended setting for Ethernet signal loss detection function selection	0 to 3, 8888, 9999	1	9999			

Function	Pr.	Pr. group	Name	Setting range	Minimum setting increments	Initial value*1		Customer setting
						Gr.1	Gr.2	
Load characteristics fault detection	1480	H520	Load characteristics measurement mode	0, 1 (2 to 5, 81 to 85)	1	0		
	1481	H521	Load characteristics load reference 1	0% to 400%, 8888, 9999	0.1%	9999		
	1482	H522	Load characteristics load reference 2	0% to 400%, 8888, 9999	0.1%	9999		
	1483	H523	Load characteristics load reference 3	0% to 400%, 8888, 9999	0.1%	9999		
	1484	H524	Load characteristics load reference 4	0% to 400%, 8888, 9999	0.1%	9999		
	1485	H525	Load characteristics load reference 5	0% to 400%, 8888, 9999	0.1%	9999		
	1486	H526	Load characteristics maximum frequency	0 to 590 Hz	0.01 Hz	60 Hz	50 Hz	
	1487	H527	Load characteristics minimum frequency	0 to 590 Hz	0.01 Hz	6 Hz		
	1488	H531	Upper limit warning detection width	0% to 400%, 9999	0.1%	20%		
	1489	H532	Lower limit warning detection width	0% to 400%, 9999	0.1%	20%		
	1490	H533	Upper limit fault detection width	0% to 400%, 9999	0.1%	9999		
	1491	H534	Lower limit fault detection width	0% to 400%, 9999	0.1%	9999		
1492	H535	Load status detection signal delay time / load reference measurement waiting time	0 to 60 s	0.1 s	1 s			
Clear parameters	PR.CL		Parameter clear	(0), 1	1	0		
	ALLC		All parameter clear	(0), 1	1	0		
	ER.CL		Fault history clear	(0), 1	1	0		
—	PR.CH		Initial value change list	—	1	0		
—	PM		PM initialization	0	1	0		
—	AUTO		Automatic parameter setting	—	—	—		
—	PR.MD		Group parameter setting	(0), 1, 2	1	0		

*1 Gr.1 and Gr.2 are the parameter initial value groups.
 *2 Differs depending on the capacity.
 6%: FR-E820-0050(0.75K) or lower, FR-E840-0026(0.75K) or lower
 5%: FR-E860-0017(0.75K)
 4%: FR-E820-0080(1.5K) to FR-E820-0175(3.7K), FR-E840-0040(1.5K) to FR-E840-0095(3.7K)
 3%: FR-E820-0240(5.5K) or higher, FR-E840-0120(5.5K) or higher, FR-E860-0027(1.5K) to 0040(2.2K)
 2%: FR-E860-0061(3.7K) or higher
 *3 Differs depending on the capacity.
 5 s: FR-E820-0175(3.7K) or lower, FR-E840-0095(3.7K) or lower, FR-E860-0061(3.7K) or lower
 10 s: FR-E820-0240(5.5K) or higher, FR-E840-0120(5.5K) or higher, FR-E860-0090(5.5K) or higher
 *4 Differs depending on the capacity.
 6%: FR-E820-0015(0.2K) or lower
 4%: FR-E820-0030(0.4K) to FR-E820-0330(7.5K), FR-E840-0016(0.4K) to FR-E840-0170(7.5K)
 1%: FR-E860-0017(0.75K) to FR-E860-0120(7.5K)
 *5 For the Ethernet model, the setting is available only when the FR-A8AY is installed.
 *6 aAvailable when the PLC function is enabled. (Pr.313 to Pr.315 are always available for settings in the Ethernet model.)
 *7 For the standard model, the setting is available only when a communication option is installed.

Protective Functions

● Error message

A message regarding operational fault or setting fault on the operation panel is displayed. The inverter output is not shut off.

Operation panel indication	Name	Description
Hold	HOLD	Operation panel lock Operation lock is set. Operation other than pressing the STOP/RESET key is disabled.
LoCd	LOCD	Password locked Password function is active. Display and setting of parameters are restricted.
Er1 to Er4	Er1 to Er4	Parameter write error Appears when an error occurred during parameter writing.
Err.	Err.	Error <ul style="list-style-type: none"> The RES signal is turned ON. This error may occur when the voltage at the input side of the inverter drops.

● Warning

The inverter output is not shut off even when a warning is displayed. However, failure to take appropriate measures will lead to a fault.

Operation panel indication	Name	Data code	Description
oLc	OLC	1 (H01)	Stall prevention (overcurrent) When the output current of the inverter increases, the stall prevention (overcurrent) function is activated.
oLv	OLV	2 (H02)	Stall prevention (overvoltage) <ul style="list-style-type: none"> When the output voltage of the inverter increases, the stall prevention (overvoltage) function is activated. The regeneration avoidance function is activated due to excessive regenerative power of the motor.
rB	RB	3 (H03)	Regenerative brake pre-alarm Appears if the regenerative brake duty reaches or exceeds 85% of the Pr.70 Special regenerative brake duty value. If the regenerative brake duty reaches 100%, a regenerative overvoltage (E. OV[]) occurs.
rH	TH	4 (H04)	Electronic thermal relay function pre-alarm Appears if the cumulative value of the electronic thermal O/L relay reaches or exceeds 85% of the preset level of Pr.9 Electronic thermal O/L relay.
pS	PS	6 (H06)	PU stop <ul style="list-style-type: none"> The motor is stopped using the STOP/RESET key under the mode other than the PU operation mode. The motor is stopped by the emergency stop function.
sL	SL	9 (H09)	Speed limit indication Output if the speed limit level is exceeded during torque control.
sA	SA	12 (H0C)	Safety stop Appears when safety stop function is activated (during output shutoff).
mT	MT	8 (H08)	Maintenance timer *3 Appears when the inverter's cumulative energization time reaches or exceeds the parameter set value.
cF	CF	10 (H0A)	Continuous operation during communication fault Appears when the operation continues while an error is occurring in the communication line or communication option (when Pr.502 = "4").
LdF	LDF	26 (H1A)	Load fault warning Appears when the load is deviated from the detection width set in Pr.1488 Upper limit warning detection width or Pr.1489 Lower limit warning detection width.
Ehr	EHR	28 (H1C)	Ethernet communication fault Appears when Ethernet communication is interrupted by physical factors while Pr.1431 Ethernet signal loss detection function selection = "1 to 3".
dIP	DIP	32 (H20)	Duplicate IP address Appears when duplicate IP address is detected.
iP	IP	38 (H26)	IP address fault Appears when the IP address or the subnet mask is out of the specified range.
sE	SE	48 (H30)	Incorrect parameter setting Appears when the combination of setting values of Pr.451 and Pr.800 is incorrect, and the inverter output is shut off.
Uv	UV	-	Stall prevention (overcurrent) If the power supply voltage of the inverter decreases, the control circuit will not perform normal functions. In addition, the motor torque will be insufficient and/or heat generation will increase. To prevent this, if the power supply voltage decreases to about 115 VAC (230 VAC for the 400 V class, 330 VAC for the 575 V class) or below, this function shuts off the inverter output and "UV" is displayed. The warning is removed when the voltage returns to normal.

● Alarm

The inverter output is not shut off. An Alarm (LF) signal can also be output with a parameter setting.

Operation panel indication	Name	Description
Fn	FN	Fan alarm For the inverter that contains a cooling fan, FN appears on the operation panel when the cooling fan stops due to a fault, low rotation speed, or different operation from the setting of Pr.244 Cooling fan operation selection.

● Fault

When a protective function is activated, the inverter output is shut off and a Fault (ALM) signal is output. The data code is used for checking the fault detail via communication or with Pr.997 Fault initiation.

◆ Data code 16 to 199

Operation panel indication	Name	Data code	Description
E.oC1	E.OC1	16 (H10)	When the inverter output current reaches or exceeds approximately 230%*4 of the rated current during acceleration, the protection circuit is activated and the inverter output is shut off.
E.oC2	E.OC2	17 (H11)	When the inverter output current reaches or exceeds approximately 230%*4 of the rated current during constant speed operation, the protection circuit is activated and the inverter output is shut off.
E.oC3	E.OC3	18 (H12)	When the inverter output current reaches or exceeds approximately 230%*4 of the rated current during deceleration (other than acceleration or constant speed), the protection circuit is activated and the inverter output is shut off.
E.ov1	E.OV1	32 (H20)	If regenerative power causes the inverter's internal main circuit DC voltage to reach or exceed the specified value, the protection circuit is activated to stop the inverter output. The circuit may also be activated by a surge voltage produced in the power supply system.
E.ov2	E.OV2	33 (H21)	If regenerative power causes the inverter's internal main circuit DC voltage to reach or exceed the specified value, the protection circuit is activated to stop the inverter output. The circuit may also be activated by a surge voltage produced in the power supply system.
E.ov3	E.OV3	34 (H22)	If regenerative power causes the inverter's internal main circuit DC voltage to reach or exceed the specified value, the protection circuit is activated to stop the inverter output. The circuit may also be activated by a surge voltage produced in the power supply system.
E.fHT	E.THT	48 (H30)	If the temperature of the output transistor elements exceeds the protection level with a rated output current or higher flowing without the overcurrent trip (E.OC[]), the inverter output is stopped. (Overload capacity 150% 60 s)
E.fHN	E.THM	49 (H31)	The electronic thermal O/L relay function in the inverter detects motor overheat, which is caused by overload or reduced cooling capability during low-speed operation. When the cumulative heat value reaches 85% of the Pr.9 Electronic thermal O/L relay setting, pre-alarm (TH) is output. When the accumulated value reaches the specified value, the protection circuit is activated to stop the inverter output.
E.f,n	E.FIN	64 (H40)	When the heatsink overheats, the temperature sensor is activated, and the inverter output is stopped.
E.uVf	E.UVT	81 (H51)	When a PM motor is used, the protective function is activated in the following case: a fault such as power failure or voltage drop occurs, the converter voltage drops to cause the motor to coast, and restarting and coasting are repeated by the automatic restart after instantaneous power failure function.
E.iLF	E.ILF	82 (H52)	When Pr.872 Input phase loss protection selection is enabled ("1") and one of the three-phase power input is lost, the inverter output is shut off.
E.oLf	E.OLT	96 (H60)	If the output frequency has fallen to 0.5 Hz by stall prevention operation and remains for 3 seconds, a fault (E.OLT) appears and the inverter is shut off. OLC or OLV appears while stall prevention is being activated.
E.Sof	E.SOT	97 (H61)	The inverter output is shut off when the motor operation is not synchronized. (This function is only available under PM sensorless vector control.)
E.LUP	E.LUP	98 (H62)	The inverter output is shut off when the load exceeds the upper limit fault detection range.
E.Ldn	E.LDN	99 (H63)	The inverter output is shut off when the load falls below the lower limit fault detection range.
E.bE	E.BE	112 (H70)	The inverter output is shut off if a fault due to damage of the brake transistor and such occurs in the brake circuit. In such a case, the power supply to the inverter must be shut off immediately.
E.GF	E.GF	128 (H80)	The inverter output is shut off if an earth (ground) fault overcurrent flows due to an earth (ground) fault that occurred on the inverter's output side (load side).
E.LF	E.LF	129 (H81)	The inverter output is shut off if one of the three phases (U, V, W) on the inverter's output side (load side) is lost.
E.oHT	E.OHT	144 (H90)	The inverter output is shut off if the external thermal relay provided for motor overheat protection or the internally mounted thermal relay in the motor, etc. switches ON (contacts open).
E.oPf	E.OPT	160 (HA0)	<ul style="list-style-type: none"> • Appears when the AC power supply is connected to terminal R/L1, S/L2, or T/L3 accidentally when a high power factor converter (FR-HC2) or multifunction regeneration converter (FR-XC in common bus regeneration mode) is connected (when Pr.30 Regenerative function selection = "0 or 2"). • Appears when the switch for manufacturer setting of the plug-in option is changed. • Appears when a communication option is connected while Pr.296 Password lock level = "0 or 100".
E.oP1	E.OP1	161 (HA1)	The inverter output is shut off if a communication line error occurs in the communication option.

Operation panel indication		Name	Data code	Description
E. 16	E.16	User definition error by the PLC function*3	164 (HA4)	The protective function is activated by setting "16 to 20" in the special register SD1214 for the PLC function. The inverter output is shut off when the protective function is activated. The protective function is activated when the PLC function is enabled.
E. 17	E.17		165 (HA5)	
E. 18	E.18		166 (HA6)	
E. 19	E.19		167 (HA7)	
E. 20	E.20		168 (HA8)	
E.PE	E.PE	Parameter storage device fault (control circuit board)	176 (HB0)	The inverter output is shut off if a fault occurs in the parameter stored. (EEPROM failure)
E.PUE	E.PUE	PU disconnection	177 (HB1)	<ul style="list-style-type: none"> The inverter output is shut off if communication between the inverter and PU is suspended, e.g. the operation panel is disconnected, when the disconnected PU detection function is valid in Pr.75 Reset selection/disconnected PU detection/PU stop selection. The inverter output is shut off if communication errors occurred consecutively for more than permissible number of retries when Pr.121 PU communication retry count ≠ "9999" during the RS-485 communication. The inverter output is shut off if communication is broken within the period of time set in Pr.122 PU communication check time interval during the RS-485 communication via the PU connector.
E.rEt	E.RET	Retry count excess*3	178 (HB2)	The inverter output is shut off if the operation cannot be resumed properly within the number of retries set in Pr.67 Number of retries at fault occurrence.
E.PE2	E.PE2	Parameter storage device fault (main circuit board)	179 (HB3)	The inverter output is shut off if a fault occurs in the inverter model information.
E.CPU	E.CPU	CPU fault	192 (HC0)	The inverter output is shut off if the communication fault of the built-in CPU occurs.
E.CdO	E.CDO	Inrush current limit circuit fault*3	196 (HC4)	The inverter output is shut off if the output current exceeds the Pr.150 Output current detection level setting.
E.IOH	E.IOH	Analog input fault	197 (HC5)	The inverter output is shut off when the resistor of the inrush current limit circuit is overheated. The inrush current limit circuit is faulty.
E.A.IE	E.AIE	Communication option fault	199 (HC7)	The inverter output is shut off when a 30 mA or higher current or a 7.5 V or higher voltage is input to terminal 2 while the current input is selected by Pr.73 Analog input selection, or to terminal 4 while the current input is selected by Pr.267 Terminal 4 input selection.

◆ Data code 200 or more

Operation panel indication		Name	Data code	Description
E.USB	E.USB	USB communication fault	200 (HC8)	The inverter output is shut off when the communication is cut off for the time set in Pr.548 USB communication check time interval.
E.SAF	E.SAF	Safety circuit fault	201 (HC9)	<ul style="list-style-type: none"> The inverter output is shut off when a safety circuit fault occurs. The inverter output is shut off if the either of the wire between S1 and SIC or S2 and SIC becomes nonconductive while using the safety stop function. When the safety stop function is not used, the inverter output is shut off when the shorting wire between terminals S1 and PC or across S2 and PC is disconnected.
E.OS	E.OS	Overspeed occurrence*3	208 (HD0)	The inverter output is shut off when the motor speed exceeds the Pr.374 Overspeed detection level under Real sensorless vector control and PM sensorless vector control.
E.OSd	E.OSD	Speed deviation excess detection	209 (HD1)	The inverter output is shut off if the motor speed is increased or decreased under the influence of the load etc. with Pr.285 Overspeed detection frequency set and cannot be controlled in accordance with the speed command value.
E.MB4	E.MB4	Brake sequence fault*3	216 (HD8)	The inverter output is shut off when a sequence error occurs during use of the brake sequence function (Pr.278 to Pr.283).
E.MB5	E.MB5		217 (HD9)	
E.MB6	E.MB6		218 (HDA)	
E.MB7	E.MB7		219 (HDB)	
E.P.d	E.PID	PID signal fault*3	230 (HE6)	The inverter output is shut off if the measured value exceeds the PID upper limit or PID lower limit parameter setting, or the absolute deviation value exceeds the PID deviation parameter setting during PID control.

Operation panel indication	Name	Data code	Description
E.EHr	E.EHR	Ethernet communication fault	231 (HE7) <ul style="list-style-type: none"> • Appears when Ethernet communication is interrupted by physical factors while Pr.1431 Ethernet signal loss detection function selection = "3" or Pr.1457 Ethernet signal loss detection function selection (extended setting) = "3". • The inverter output is shut off if Ethernet communication is broken for the time set in Pr.1432 Ethernet communication check time interval or longer for all devices with IP addresses in the range specified for Ethernet command source selection (Pr.1449 to Pr.1454). • Check that the Pr.1432 setting is not too short. • When the CC-Link IE Field Network Basic is used, the inverter output is shut off in the following cases: the data addressed to the own station is not received for the predetermined timeout period or longer, or the status bit of the cyclic transmission addressed to the own station turns OFF (when the master inverter gives a command to stop the cyclic transmission). • When BACnet/IP is used, the inverter output will be shut off after the time period set in Pr.1432 after power is supplied to the inverter if an IP address of any other inverter falls within the Ethernet IP address range set for command source selection.
E.CM6	E.CMB	Board combination mismatch	232 (HE8) The board combination is not appropriate.
E. 1	E.1	Option fault	241 (HF1) <ul style="list-style-type: none"> • The inverter output is shut off when a contact fault is found between the inverter and the plug-in option, or when the communication option is not connected to the connector 1. • Appears when the switch for manufacturer setting of the plug-in option is changed.
E. 5	E.5	CPU fault	245 (HF5)
E. 6	E.6		246 (HF6)
E. 7	E.7		247 (HF7)
E. 10	E.10	Output side fault	250 (HFA) The inverter output is shut off if the inverter detects an output current fault such as an earth (ground) fault that occurred on the inverter's output side (load side).
E. 11	E.11	Opposite rotation deceleration fault*3	251 (HFB) The speed may not decelerate during low speed operation if the rotation direction of the speed command and the estimated speed differ when the rotation is changing from forward to reverse or from reverse to forward during torque control under Real sensorless vector control. The inverter output is shut off when overload occurs due to the un-switched rotation direction.
E. 13	E.13	Internal circuit fault (15 V poser supply)	253 (HFD) Appears when the internal circuit is faulty.

● Others

The fault history and the operation status of the inverter are displayed. It is not a fault indication.

Operation panel indication	Name	Description
E - - -	Fault history	The operation panel stores the fault indications which appear when a protective function is activated to display the fault record for the past 10 faults.

- *1 Resetting the inverter initializes the internal cumulative heat value of the electronic thermal O/L relay function.
- *2 The external thermal operates only when the OH signal is set in Pr.178 to Pr.189 (input terminal function selection).
- *3 This protective function is not available in the initial status.
- *4 Differs according to ratings. The rating can be changed using Pr.570 Multiple rating setting.
170% for LD rating, 230% for ND rating (initial setting) (FR-E820-0175(3.7K) or lower, FR-E840-0095(3.7K) or lower, FR-E860-0061(3.7K) or lower), and 235% for ND rating (initial value) (FR-E820-0240(5.5K) or higher, FR-E840-0120(5.5K) or higher, FR-E860-0090(5.5K) or higher)

Standard Specifications

◆ Three-phase 200 V power supply

Model FR-E820-[]			0.1K	0.2K	0.4K	0.75K	1.5K	2.2K	3.7K	5.5K	7.5K
			0008	0015	0030	0050	0080	0110	0175	0240	0330
Applicable motor capacity (kW)*1	LD		0.2	0.4	0.75	1.1	2.2	3.0	5.5	7.5	11
	ND		0.1	0.2	0.4	0.75	1.5	2.2	3.7	5.5	7.5
Rated capacity (kVA)*2	LD		0.5	0.8	1.4	2.4	3.8	4.8	7.8	12.0	15.9
	ND		0.3	0.6	1.2	2.0	3.2	4.4	7.0	9.6	13.1
Rated current (A)*7	LD		1.3 (1.1)	2 (1.7)	3.5 (3.0)	6.0(5.1)	9.6 (8.2)	12 (10.2)	19.6 (16.7)	30 (25.5)	40 (34)
	ND		0.8 (0.8)	1.5 (1.4)	3 (2.5)	5 (4.1)	8 (7)	11 (10)	17.5 (16.5)	24 (23)	33 (31)
Overload current rating*3	LD		120% 60 s, 150% 3 s (inverse-time characteristics) at surrounding air temperature of 50°C								
	ND		150% 60 s, 200% 3 s (inverse-time characteristics) at surrounding air temperature of 50°C								
Rated voltage*4			Three-phase 200 to 240 V								
Regenerative braking	Brake transistor		-			Built-in					
	Maximum brake torque*5		150%			100%		50%		20%	
Rated input AC voltage/frequency			Three-phase 200 to 240 V 50 Hz / 60 Hz								
Permissible AC voltage fluctuation			170 to 264 V 50 Hz / 60 Hz								
Permissible frequency fluctuation			±5%								
Rated input current (A)*8	LD	Without DC reactor	1.9	3.0	5.1	8.2	13	16	26	37	49
		With DC reactor	1.3	2.0	3.5	6.0	9.6	12	20	30	40
	ND	Without DC reactor	1.4	2.3	4.5	7.0	11	15	23	30	41
		With DC reactor	0.8	1.5	3.0	5.0	8.0	11	17.5	24	33
Power supply capacity (kVA)*6	LD	Without DC reactor	0.7	1.1	1.9	3.1	4.8	6.2	9.7	14	19
		With DC reactor	0.5	0.8	1.3	2.3	3.7	4.6	7.5	11	15
	ND	Without DC reactor	0.5	0.9	1.7	2.7	4.1	5.7	8.8	12	16
		With DC reactor	0.3	0.6	1.1	1.9	3.0	4.2	6.7	9.1	13
Protective structure (IEC 60529)			Enclosed type (IP20)								
Cooling system			Natural				Forced air				
Approximate mass (kg)			0.5	0.5	0.7	1.0	1.4	1.4	1.8	3.3	3.3

◆ Three-phase 400 V class

Model FR-E840-[]			0.4K	0.75K	1.5K	2.2K	3.7K	5.5K	7.5K
			0016	0026	0040	0060	0095	0120	0170
Applicable motor capacity (kW)*1	LD		0.75	1.5	2.2	3.0	5.5	7.5	11
	ND		0.4	0.75	1.5	2.2	3.7	5.5	7.5
Rated capacity (kVA)*2	LD		1.6	2.7	4.2	5.3	8.5	13.3	17.5
	ND		1.2	2.0	3.0	4.6	7.2	9.1	13.0
Rated current (A)*7	LD		2.1 (1.8)	3.5 (3.0)	5.5 (4.7)	6.9 (5.9)	11.1 (9.4)	17.5 (14.9)	23 (19.6)
	ND		1.6 (1.4)	2.6 (2.2)	4 (3.8)	6 (5.4)	9.5 (8.7)	12	17
Overload current rating*3	LD		120% 60 s, 150% 3 s (inverse-time characteristics) at surrounding air temperature of 50°C						
	ND		150% 60 s, 200% 3 s (inverse-time characteristics) at surrounding air temperature of 50°C						
Rated voltage*4			Three-phase 380 to 480 V						
Regenerative braking	Brake transistor		Built-in						
	Maximum brake torque*5		100%		50%		20%		
Rated input AC voltage/frequency			Three-phase 380 to 480 V 50 Hz / 60 Hz						
Permissible AC voltage fluctuation			323 to 528 V 50 Hz / 60 Hz						
Permissible frequency fluctuation			±5%						
Rated input current (A)*8	LD	Without DC reactor	3.3	6.0	8.9	11	16	25	32
		With DC reactor	2.1	3.5	5.5	6.9	11	18	23
	ND	Without DC reactor	2.7	4.4	6.7	9.5	14	18	25
		With DC reactor	1.6	2.6	4.0	6.0	9.5	12	17
Power supply capacity (kVA)*6	LD	Without DC reactor	2.5	4.5	6.8	8.2	12	19	25
		With DC reactor	1.6	2.7	4.2	5.3	8.5	13	18
	ND	Without DC reactor	2.1	3.4	5.1	7.2	11	14	19
		With DC reactor	1.2	2.0	3.0	4.6	7.2	9.1	13
Protective structure (IEC 60529)			Enclosed type (IP20)						
Cooling system			Natural			Forced air			
Approximate mass (kg)			1.2	1.2	1.4	1.8	1.8	2.4	2.4

*1 The applicable motor capacity indicated is the maximum capacity applicable for use of the Mitsubishi Electric 4-pole standard motor.

*2 The rated output capacity indicated assumes that the output voltage is 230 V for three-phase 200 V class and 440 V for three-phase 400 V class.

*3 The % value of the overload current rating indicated is the ratio of the overload current to the inverter's rated output current. For repeated duty, allow time for the inverter and motor to return to or below the temperatures under 100% load.

*4 The maximum output voltage does not exceed the power supply voltage. The maximum output voltage can be changed within the setting range. However, the pulse voltage value of the inverter output side voltage remains unchanged at about $\sqrt{2}$ that of the power supply.

*5 The braking torque indicated is a short-duration average torque (which varies with motor loss) when the motor alone is decelerated from 60 Hz in the shortest time and is not a continuous regenerative torque. When the motor is decelerated from the frequency higher than the base frequency, the average deceleration torque will reduce. Since the inverter does not contain a brake resistor, use the optional brake resistor when regenerative energy is large. A brake unit (FR-BU2) may also be used. (Option brake resistor cannot be used for 0.1K and 0.2K.)

*6 The power supply capacity varies with the value of the power supply side inverter impedance (including those of the input reactor and cables).

*7 Setting 2 kHz or more in **Pr. 72 PWM frequency selection** to perform low acoustic noise operation in the surrounding air temperature exceeding 40°C, the rated output current is the value in parenthesis.

*8 The rated input current is the value when at the rated output current. The input power impedances (including those of the input reactor and cables) affect the value.

◆ Three-phase 575 V class

Model FR-E860-□			0.75K	1.5K	2.2K	3.7K	5.5K	7.5K	
			0017	0027	0040	0061	0090	0120	
Applicable motor capacity (kW)*1	LD		1.5	2.2	3.7	5.5	7.5	11	
	ND		0.75	1.5	2.2	3.7	5.5	7.5	
Output	Rated capacity (kVA)*2	LD	2.5	3.6	5.6	8.2	11.0	15.9	
		ND	1.7	2.7	4.0	6.1	9.0	12.0	
	Rated current (A)*7	LD	2.5 (2.1)	3.6 (3.0)	5.6 (4.8)	8.2 (7.0)	11 (9.0)	16 (13.6)	
		ND	1.7	2.7	4	6.1	9	12	
	Overload current rating*3	LD	120% 60 s, 150% 3 s (inverse-time characteristics) at surrounding air temperature of 50°C						
		ND	150% 60 s, 200% 3 s (inverse-time characteristics) at surrounding air temperature of 50°C						
Rated voltage*4		Three-phase 525 to 600 V							
Regenerative braking	Brake transistor		Built-in						
	Maximum brake torque*5		100%	50%	20%				
Power supply	Rated input AC voltage/frequency		Three-phase 575 V 60 Hz						
	Permissible AC voltage fluctuation		490 to 632 V 60 Hz						
	Permissible frequency fluctuation		±5%						
	Rated input current (A)*8	LD	Without DC reactor	4.3	5.9	8.9	12	16	22
			With DC reactor	2.5	3.6	5.6	8.2	11	16
		ND	Without DC reactor	3.0	4.6	6.6	10	13	17
			With DC reactor	1.7	2.7	4.0	6.1	9.0	12
	Power supply capacity (kVA)*6	LD	Without DC reactor	4.3	5.9	8.9	12	16	22
			With DC reactor	2.5	3.6	5.6	8.2	11	16
		ND	Without DC reactor	3.0	4.6	6.6	9.5	13	17
With DC reactor			1.7	2.7	4.0	6.1	9.0	12	
Protective structure (IEC 60529)			Enclosed type (IP20)						
Cooling system			Natural		Forced air				
Approximate mass (kg)			1.9	1.9	1.9	2.4	2.4	2.4	

- *1 The motor capacity indicates the maximum capacity of a 4-pole standard motor driven by all of the inverters in parallel connection.
- *2 The rated output capacity indicated assumes that the output voltage is 575 V.
- *3 The % value of the overload current rating indicated is the ratio of the overload current to the inverter's rated output current. For repeated duty, allow time for the inverter and motor to return to or below the temperatures under 100% load.
- *4 The maximum output voltage does not exceed the power supply voltage. The maximum output voltage can be changed within the setting range. However, the pulse voltage value of the inverter output side voltage remains unchanged at about $\sqrt{2}$ that of the power supply.
- *5 The amount of braking torque is the average short-term torque (which varies depending on motor loss) that is generated when a motor decelerates in the shortest time by itself from 60 Hz. It is not continuous regenerative torque. The average deceleration torque becomes lower when a motor decelerates from a frequency higher than the base frequency. The inverter is not equipped with a built-in brake resistor. Use a brake resistor for an operation with large regenerative power. A brake unit can be also used.
- *6 The power supply capacity varies with the value of the power supply side inverter impedance (including those of the input reactor and cables).
- *7 Setting 2 kHz or more in **Pr. 72 PWM frequency selection** to perform low acoustic noise operation in the surrounding air temperature exceeding 40°C, the rated output current is the value in parenthesis.
- *8 The rated input current indicates a value at a rated output voltage. The impedance at the power supply side (including those of the input reactor and cables) affects the rated input current.

● Common specifications

Control specifications	Control method		Soft-PWM control/high carrier frequency PWM control	
	Induction motor	Induction motor	Selectable among V/F control, Advanced magnetic flux vector control, and Real sensorless vector control	
		PM motor	PM sensorless vector control	
	Output frequency range	Induction motor	0.2 to 590 Hz (The upper-limit frequency is 400 Hz under Advanced magnetic flux vector control and Real sensorless vector control.)	
		PM motor	0.2 to 400 Hz (not operable at maximum motor frequency or higher)	
	Frequency setting resolution	Analog input	0.015 Hz /60 Hz at 0 to 10 V / 12 bits (terminals 2 and 4) 0.03 Hz /60 Hz at 0 to 5 V / 11 bits or 0 to 20 mA / 11 bits (terminals 2 and 4)	
		Digital input	0.01 Hz	
	Frequency accuracy	Analog input	Within ±0.2% of the max. output frequency (25°C ±10°C)	
		Digital input	Within 0.01% of the set output frequency	
	Voltage/frequency characteristics			Base frequency can be set from 0 to 590 Hz. Constant-torque/variable torque pattern can be selected. (available with induction motors only)
	Starting torque	Induction motor	150% 0.5 Hz (Advanced magnetic flux vector control) 200% 0.3 Hz (0.4K to 3.7K), 150% 0.3 Hz (5.5K or more) (Real sensorless vector control)	
		PM motor	50%	
	Torque boost			Manual torque boost (available with induction motors only)
	Acceleration/deceleration time setting			0 to 3600 s (acceleration and deceleration can be set individually), linear or S-pattern acceleration/deceleration mode
DC injection brake	Induction motor	Operation frequency (0 to 120 Hz), operation time (0 to 10 s), operation voltage (0 to 30%) can be changed.		
	PM motor	Operation time (0 to 10 s) can be changed, operation voltage (operating current) is fixed.		
Stall prevention operation level			Operation current level can be set (0 to 220% adjustable), whether to use the function or not can be selected.	
Torque limit level			Torque limit value can be set (0 to 400% variable).	
Operation specifications	Frequency setting signal	Analog input	Terminals 2 and 4: 0 to 10 V, 0 to 5 V, 4 to 20 mA (0 to 20 mA) are available.	
		Digital input	Input using the operation panel. Four-digit BCD or 16-bit binary (when used with option FR-A8AX E kit)	
	Start signal			Forward and reverse rotation or start signal automatic self-holding input (3-wire input) can be selected.
	Input signal (standard model: 7, Ethernet model: 2)			Low-speed operation command, Middle-speed operation command, High-speed operation command, Output stop, Forward rotation command, Reverse rotation command, Inverter reset The input signal can be changed using Pr.178 to Pr.189 (input terminal function selection) .
	Operational functions			Maximum and minimum frequency settings, multi-speed operation, acceleration/deceleration pattern, thermal protection, DC injection brake, starting frequency, JOG operation, output stop (MRS), stall prevention, regeneration avoidance, frequency jump, rotation display, automatic restart after instantaneous power failure, remote setting, automatic acceleration/deceleration, retry function, carrier frequency selection, fast-response current limit, forward/reverse rotation prevention, operation mode selection, slip compensation, droop control, speed smoothing control, traverse, auto tuning, applied motor selection, RS-485 communication*1, Ethernet communication*2, PID control, easy dancer control, cooling fan operation selection, stop selection (deceleration stop/coasting), power-failure deceleration stop function, stop-on-contact control, PLC function, life diagnosis, maintenance timer, current average monitor, multiple rating, speed control, torque control, torque limit, safety stop function
	Output signal	Open collector output (standard model: 2) Relay output (1)		Inverter running, Up to frequency, Fault The output signal can be changed using Pr.190 to Pr.196 (output terminal function selection).
		Analog output (AM type)		-10 to +10 V / 12 bits
	Protective/warning function	Protective functions		Overcurrent trip during acceleration, Overcurrent trip during constant speed, Overcurrent trip during deceleration or stop, Regenerative overvoltage trip during acceleration, Regenerative overvoltage trip during constant speed, Regenerative overvoltage trip during deceleration or stop, Inverter overload trip, Motor overload trip, Heat sink overheat, Undervoltage, Input phase loss, Stall prevention stop, Loss of synchronism detection*3, Upper limit fault detection, Lower limit fault detection, Brake transistor alarm detection, Output side earth (ground) fault overcurrent, Output short circuit, Output phase loss, External thermal relay operation, Option fault, Communication option fault, Parameter storage device fault, PU disconnection, Retry count excess, CPU fault, Abnormal output current detection, Inrush current limit circuit fault, USB communication fault, analog input error, Safety circuit fault, Overspeed occurrence*3, Speed deviation excess detection*3, Brake sequence fault*3, PID signal fault, Ethernet communication fault*2, Opposite rotation deceleration fault*3, Internal circuit fault, User definition error by the PLC function, Board combination mismatch
		Warning functions		Fan alarm, Stall prevention (overcurrent), Stall prevention (overvoltage), Regenerative brake pre-alarm*3, Electronic thermal relay function pre-alarm, PU stop, Maintenance timer warning, Parameter write error, Operation panel lock*3, Password locked, Speed limit indication, Safety stop, Ethernet communication fault*2, Duplicate IP address*2, IP address fault*2, Incorrect parameter setting
	Environment	Surrounding air temperature		-20°C to +60°C (-10°C to +60°C for the 575 V class) (The rated current must be reduced at a temperature above 50°C.)
Ambient humidity		95% RH or less (non-condensing) (With circuit board coating (conforming to IEC 60721-3-3 3C2)) 90% RH or less (non-condensing) (Without circuit board coating)		
Storage temperature*4		-40°C to +70°C		
Atmosphere		Indoors (without corrosive gas, flammable gas, oil mist, dust and dirt, etc.)		
Altitude/vibration*5		Maximum 3000 m (Maximum 2000 m for the 575 V class), 5.9 m/s ² or less at 10 to 55 Hz (directions of X, Y, Z axes)		

*1 Enabled only for standard models.

*2 Enabled only for Ethernet models.

*3 This protective function is not available in the initial status.

*4 Temperature applicable for a short time, e.g. in transit.

*5 For the installation at an altitude above 1000 m, consider a 3% reduction in the rated current per 500 m increase in altitude.

Outline Dimensions

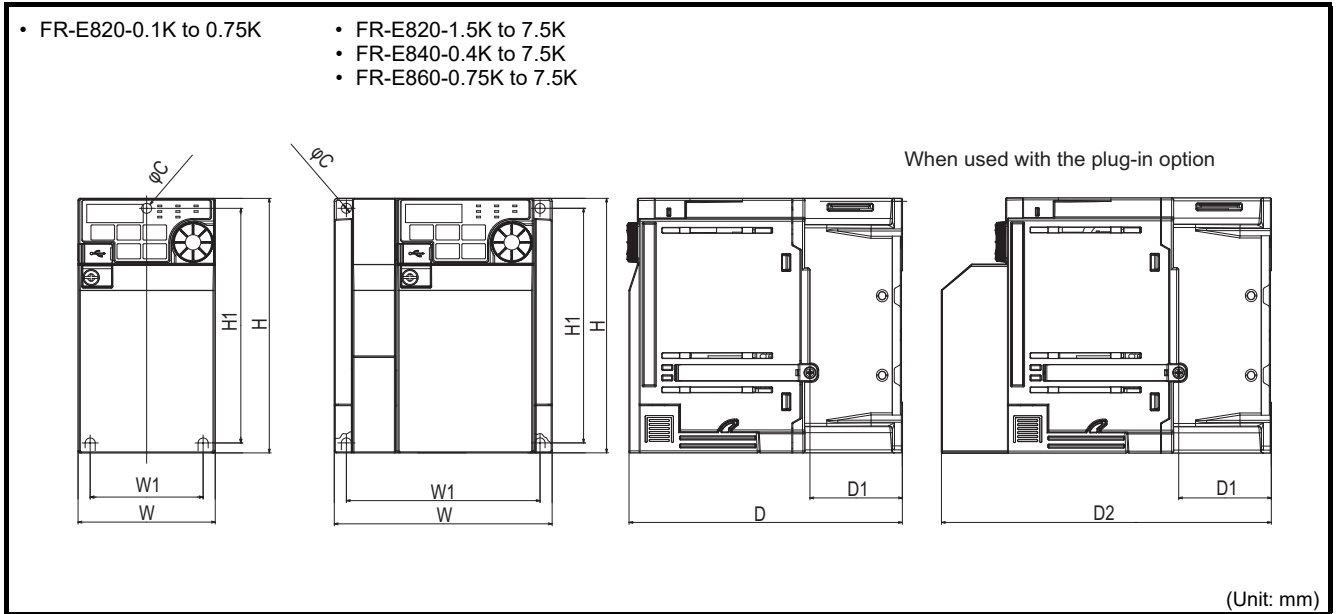

• Three-phase 200 V class

Inverter model	W	W1	H	H1	D	D1	D2	C
FR-E820-0.1K	68	56	128	118	80.5	10	108.1	5
FR-E820-0.2K					112.5	42	140.1	
FR-E820-0.4K					132.5	42	160.1	
FR-E820-0.75K	108	96	260	244	135.5	46	163.1	6
FR-E820-1.5K	140	128			142.5	52.5	170.1	
FR-E820-2.2K	180	164	260	244	165	71.5	192.6	6
FR-E820-3.7K								
FR-E820-5.5K								
FR-E820-7.5K								

• Three-phase 400 V class

Inverter model	W	W1	H	H1	D	D1	D2	C
FR-E840-0.4K	108	96	128	118	129.5	40	157.1	5
FR-E840-0.75K					135	46	162.6	
FR-E840-1.5K					135	43.5	162.6	
FR-E840-2.2K	140	128	150	138	147	68	174.6	
FR-E840-3.7K	220	208	150	138	147	68	174.6	
FR-E840-5.5K								
FR-E840-7.5K								

• Three-phase 575 V class

Inverter model	W	W1	H	H1	D	D1	D2	C
FR-E860-0.75K	140	128	150	138	135	43.5	162.6	5
FR-E860-1.5K								
FR-E860-2.2K					147	68	174.6	
FR-E860-3.7K	220	208	150	138	147	68	174.6	
FR-E860-5.5K								
FR-E860-7.5K								

Terminal Connection Diagram

E800

Sink logic

- ⊙ Main circuit terminal
- Control circuit terminal

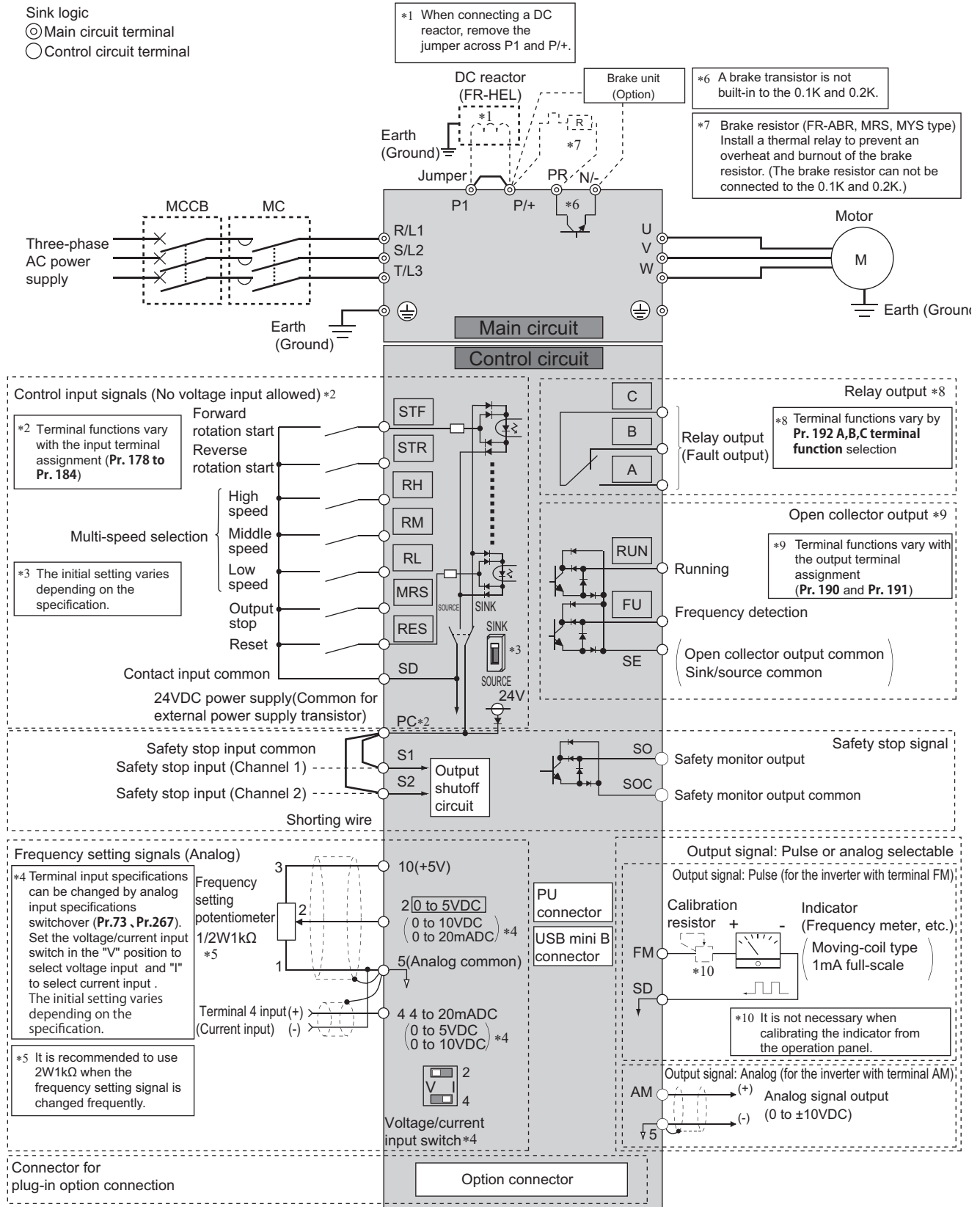

6

Terminal Connection Diagram, Terminal Specifications

Type	Terminal Symbol	Terminal Name	Description		
Main circuit	R/L1, S/L2, T/L3	AC power input	Connect to the commercial power supply. Do not connect anything to these terminals when using the high power factor converter (FR-HC2) or the multifunction regeneration converter (FR-XC) in common bus regeneration mode.		
	U, V, W	Inverter output	Connect a three-phase squirrel-cage motor or PM motor.		
	P/+, PR	Brake resistor connection	Connect a brake transistor (MRS type, MYS type, FR-ABR) across terminals P/+ -PR. (The brake resistor cannot be connected to the 0.1K or 0.2K)		
	P/+, N/-	Brake unit connection	Connect the brake unit (FR-BU2), multifunction regeneration converter (FR-XC), or high power factor converter (FR-HC2).		
	P/+, P1	DC reactor connection	Remove the jumper across terminals P/+ -P1 and connect a DC reactor. When a DC reactor is not connected, the jumper across terminals P/+ and P1 should not be removed.		
		Earth (Ground)	For earthing (grounding) the inverter chassis. Must be earthed (grounded).		
input signal	Contact input	STF*1	Forward rotation start	Turn on the STF signal to start forward rotation and turn it off to stop.	When the STF and STR signals are turned on simultaneously, the stop command is given.
		STR*1	Reverse rotation start	Turn on the STR signal to start reverse rotation and turn it off to stop.	
		RH, RM, RL*1	Multi-speed selection	Multi-speed can be selected according to the combination of RH, RM and RL signals.	
		MRS*1	Output stop	Turn on the MRS signal (20ms or more) to stop the inverter output. Use to shut off the inverter output when stopping the motor by electromagnetic brake.	
		RES*1	Reset	Use to reset alarm output provided when protective circuit is activated. Turn on the RES signal for more than 0.1s, then turn it off. It is possible to set the initial setting to "always enabled". By setting Pr. 75, reset can be set enabled only at fault occurrence. Recover about 1s after reset is cancelled.	
	SD	Contact input common (sink)	Common terminal for contact input terminal (sink logic) and terminal FM.		
		External transistor common (source)	Connect this terminal to the power supply common terminal of a transistor output (open collector output) device, such as a programmable controller, in the source logic to avoid malfunction by undesirable currents.		
		24VDC power supply common	Common output terminal for 24VDC 0.1A power supply (PC terminal). Isolated from terminals 5 and SE.		
		PC	External transistor common (sink)	Connect this terminal to the power supply common terminal of a transistor output (open collector output) device, such as a programmable controller, in the sink logic to avoid malfunction by undesirable currents.	
	PC	Safety stop input terminal common	Common terminal for safety stop input terminals.		Power supply voltage range: 22 to 26.5 VDC, permissible load current: 100 mA
		Contact input common (source)	Common terminal for contact input terminal (source logic).		
		24VDC power supply	Can be used as 24 VDC 0.1 A power supply.		
	Frequency setting	10	Frequency setting power supply	Used as power supply when connecting potentiometer for frequency setting (speed setting) from outside of the inverter.	5 VDC ± 0.5 V permissible load current 10 mA
		2	Frequency setting (voltage)	Inputting 0 to 5 VDC (or 0 to 10 VDC) provides the maximum output frequency at 5 V (or 10 V) and makes input and output proportional. Use Pr.73 to switch between input 0 to 5 VDC (initial setting) and 0 to 10 VDC input (The initial setting varies depending on the specification). Set the voltage/current input switch to the "I" position to select current input (0 to 20 mA).	Voltage input: Input resistance 10 kΩ ± 1 kΩ Permissible maximum voltage 20 VDC Current input: Input resistance 245 Ω ± 5 Ω Maximum permissible current 30 mA.
		4	Frequency setting (current)	Inputting 4 to 20 mADC (or 0 to 5 VDC, 0 to 10 VDC) provides the maximum output frequency at 20 mA and makes input and output proportional. This input signal is valid only when the AU signal is ON (terminal 2 input is invalid). To use the terminal 4 (current input at initial setting), assign "4" to any parameter from Pr.178 to Pr.184 (Input terminal function selection) before turning ON the AU signal (The initial setting varies depending on the specification). Use Pr.267 to switch among input 4 to 20 mA (initial setting), 0 to 5 VDC, and 0 to 10 VDC. Set the voltage/current input switch in the "V" position to select voltage input (0 to 5 V / 0 to 10 V).	
5		Frequency setting common	Common terminal for the frequency setting signals (terminals 2 or 4). Do not earth (ground).		
output signal		Relay	A, B, C	Relay output (fault output)	1 changeover contact output indicates that the inverter fault occurs. Fault: discontinuity across B-C (continuity across A-C), Normal: continuity across B-C (discontinuity across A-C)
	Open collector	RUN	Inverter running	The output is in LOW state when the inverter output frequency is equal to or higher than the starting frequency (initial value: 0.5 Hz). The output is in HIGH state during stop or DC injection brake operation.*2	Permissible load 24 VDC (Maximum 27 VDC) 0.1 A (a voltage drop is 3.4 V maximum when the signal is on)
		FU	Frequency detection	The output is in LOW state when the inverter output frequency is equal to or higher than the preset detection frequency, and is in HIGH state when it is less than the preset detection frequency.*2	
		SE	Open collector output common	Common terminal of terminal RUN and FU.	
	Pulse	FM*3	For meter	Select one e.g. output frequency from monitor items. (Not output during inverter reset). The output signal is proportional to the magnitude of the corresponding monitoring item.	Output item: output frequency (initial setting)
Analog	AM*3	Analog voltage output			Output signal 0 to ±10 VDC, permissible load current 1 mA (load impedance 10 kΩ or more), resolution 8 bit
Safety stop signal	S1	Safety stop input (Channel 1)	Terminals S1 and S2 are used for the safety stop input signal for the safety relay module. Terminals S1 and S2 are used at the same time (dual channel). Inverter output is shutoff by shortening/opening between terminals S1 and SIC, or between S2 and SIC. In the initial status, terminals S1 and S2 are shorted with terminal PC by shorting wires. Terminal SIC is shorted with terminal SD. Remove the shorting wires and connect the safety relay module when using the safety stop function.		Input resistance 4.7 kΩ Voltage when contacts are open 21 to 26 VDC Current when contacts are short-circuited 4 to 6 mADC
	S2	Safety stop input (with 24 VDC input) (Channel 2)			
	SO	Safety monitor output (open collector output)	Indicates the safety stop input signal status. Switched to LOW when the status is other than the internal safety circuit failure. Refer to the FR-E800 Instruction Manual (Functional Safety) (BCN-A23488-000) when the signal is switched to HIGH while both terminals S1 and S2 are open. (Please contact your sales representative for the manual.)		Permissible load 24 VDC (maximum 27 VDC) 0.1 A (The voltage drop is 3.4 V at maximum while the signal is ON.)
	SOC	Safety monitor output terminal common	Common terminal for terminal SO.		
Communication	—	PU connector	With the PU connector, RS-485 communication can be made. · Conforming standard: EIA-485 (RS-485) · Transmission format: Multi-drop link · Communication speed: 300 to 115200bps · Overall extension: 500m		
	—	USB connector*4	USB connection with a personal computer can be established. Setting, monitoring and testing of the inverter can be performed using FR Configurator2. · Interface: conforms to USB 1.1 · Transmission Speed: 12 Mbps · Connector: USB mini B connector (receptacle mini B type)		

*1 Terminal functions can be selected using Pr.178 to Pr.184 (Input terminal function selection).
 *2 An open collector transistor is ON (conductive) in LOW state. The transistor is OFF (not conductive) in HIGH state.
 *3 Terminal FM is provided for the FM type inverter. Terminal AM is provided for the AM type inverter.
 *4 USB bus power connection is available. The maximum SCCR should be 500 mA. A PU connector cannot be used during USB bus power connection.

Terminal Connection Diagram

E800-E

Sink logic

- ⊙ Main circuit terminal
- Control circuit terminal

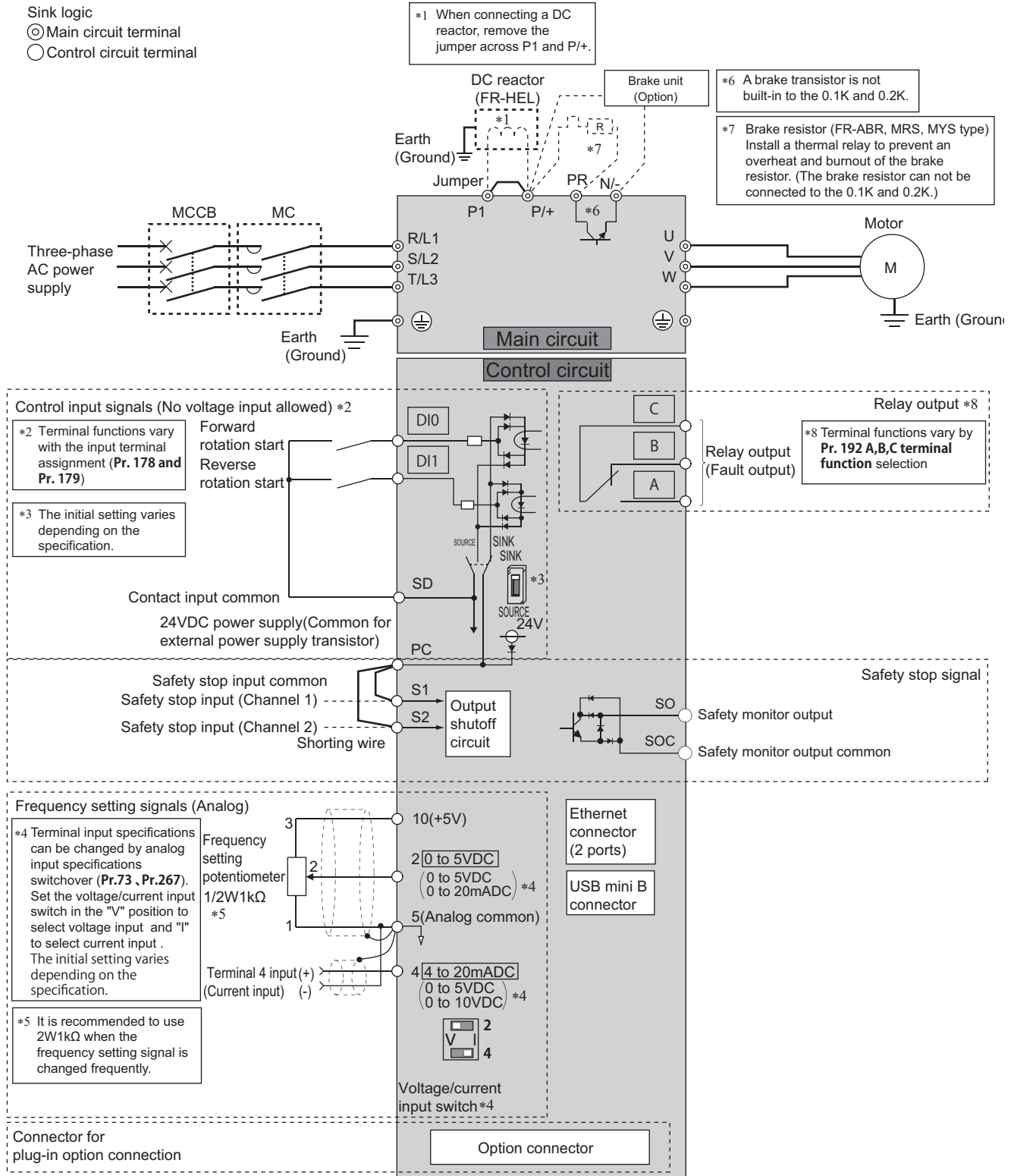

6

Terminal Connection Diagram, Terminal Specifications

Terminal Specifications E800-E

Type	Terminal Symbol	Terminal Name	Description			
Main circuit	R/L1, S/L2, T/L3	AC power input	Connect to the commercial power supply. Do not connect anything to these terminals when using the high power factor converter (FR-HC2) or the multifunction regeneration converter (FR-XC) in common bus regeneration mode.			
	U, V, W	Inverter output	Connect a three-phase squirrel-cage motor or PM motor.			
	P/+, PR	Brake resistor connection	Connect a brake transistor (MRS type, MYS type, FR-ABR) across terminals P/+ - PR. (The brake resistor cannot be connected to the 0.1K or 0.2K)			
	P/+, N/-	Brake unit connection	Connect the brake unit (FR-BU2), multifunction regeneration converter (FR-XC), or high power factor converter (FR-HC2).			
	P/+, P1	DC reactor connection	Remove the jumper across terminals P/+ - P1 and connect a DC reactor. When a DC reactor is not connected, the jumper across terminals P/+ and P1 should not be removed.			
		Earth (Ground)	For earthing (grounding) the inverter chassis. Must be earthed (grounded).			
input signal	DI0*1	Forward rotation start	Turn on the DI0 signal to start forward rotation and turn it off to stop.	When the DI0 and DI1 signals are turned on simultaneously, the stop command is given.	Input resistance: 4.7 kΩ, voltage when contacts are open: 21 to 26 VDC, current when contacts are short-circuited: 4 to 6 mADC	
		DI1*1	Reverse rotation start			Turn on the DI1 signal to start reverse rotation and turn it off to stop.
	SD	Contact input common (sink)	Common terminal for contact input terminal (sink logic).			
		External transistor common (source)	Connect this terminal to the power supply common terminal of a transistor output (open collector output) device, such as a programmable controller, in the source logic to avoid malfunction by undesirable current.			
		24 VDC power supply common	Common output terminal for 24 VDC 0.1 A power supply (PC terminal). Isolated from terminals 5 and SE.			
		PC	External transistor common (sink)	Connect this terminal to the power supply common terminal of a transistor output (open collector output) device, such as a programmable controller, in the sink logic to avoid malfunction by undesirable current.	Power supply voltage range: 22 to 26.5 VDC, permissible load current: 100 mA	
	Safety stop input terminal common	Common terminal for safety stop input terminals.				
	Contact input common (source)	Common terminal for the contact input terminal (source logic).				
		24 VDC power supply	Can be used as 24 VDC 0.1 A power supply.			
	Frequency setting	10	Frequency setting power supply	Used as power supply when connecting potentiometer for frequency setting (speed setting) from outside of the inverter.	5 VDC ± 0.5 V permissible load current 10 mA	
		2	Frequency setting (voltage)	Inputting 0 to 5 VDC (or 0 to 10 V) provides the maximum output frequency at 5 V (10 V) and makes input and output proportional. Use Pr. 73 to switch between input 0 to 5 VDC (initial setting) and 0 to 10 VDC input (The initial setting varies depending on the specification). Set the voltage/current input switch to the "I" position to select current input (0 to 20 mA).	Voltage input: Input resistance 10 kΩ ± 1 kΩ Permissible maximum voltage 20 VDC Current input: Input resistance 245 Ω ± 5 Ω Maximum permissible current 30 mA.	
		4	Frequency setting (current)	Inputting 0 to 20 mADC (or 0 to 5 V / 0 to 10 V) provides the maximum output frequency at 20 mA makes input and output proportional. This input signal is valid only when the AU signal is on (terminal 2 input is invalid). To use terminal 4 (initial setting is current input), set "4" to any of Pr. 178, Pr. 179 (input terminal function selection), and turn AU signal ON (The initial setting varies depending on the specification). Use Pr. 267 to switch from among input 4 to 20 mA (initial setting), 0 to 5 VDC and 0 to 10 VDC. Set the voltage/current input switch in the "V" position to select voltage input (0 to 5 V / 0 to 10 V).		
		5	Frequency setting common	Common terminal for the frequency setting signals (terminals 2 or 4). Do not earth (ground).		
	output signal	Relay	A, B, C	Relay output (fault output)	1 changeover contact output indicates that the inverter fault occurs. Fault: discontinuity across B-C (continuity across A-C), Normal: continuity across B-C (discontinuity across A-C)	Contact capacity 240 VAC 2 A (power factor = 0.4) 30 VDC 1 A
Safety stop signal	S1	Safety stop input (Channel 1)	Terminals S1 and S2 are used for the safety stop input signal for the safety relay module. Terminals S1 and S2 are used at the same time (dual channel). Inverter output is shutoff by shortening/opening between terminals S1 and SIC, or between S2 and SIC. In the initial status, terminals S1 and S2 are shorted with terminal PC by shorting wires. Terminal SIC is shorted with terminal SD. Remove the shorting wires and connect the safety relay module when using the safety stop function.		Input resistance 4.7 kΩ Voltage when contacts are open 21 to 26 VDC Current when contacts are short-circuited 4 to 6 mADC	
	S2	Safety stop input (with 24 VDC input) (Channel 2)				
	SO	Safety monitor output (open collector output)	Indicates the safety stop input signal status. Switched to LOW when the status is other than the internal safety circuit failure. Switched to HIGH during the internal safety circuit failure status. (LOW is when the open collector output transistor is ON (conducted). HIGH is when the transistor is OFF (not conducted).) Refer to the FR-E800 Instruction Manual (Functional Safety) (BCN-A23488-000) when the signal is switched to HIGH while both terminals S1 and S2 are open. (Please contact your sales representative for the manual.)		Permissible load 24 VDC (maximum 27 VDC) 0.1 A (The voltage drop is 3.4 V at maximum while the signal is ON.)	
	SOC	Safety monitor output terminal common	Common terminal for terminal SO.			
Communication	—	Ethernet connector (2-port) *2	Communication can be made via Ethernet. · Category: 100BASE-TX/10BASE-T · Data transmission speed: 100 Mbps (100BASE-TX) / 10 Mbps (10BASE-T) · Transmission method: Baseband · Maximum segment length: 100m between the hub and the inverter · Number of cascade connection stages: Up to 2 (100BASE-TX) / up to 4 (10BASE-T) · Interface: RJ-45 · Number of interfaces available: 2 · IP version: IPv4			
	—	USB connector *3	USB connection with a personal computer can be established. Setting, monitoring and testing of the inverter can be performed using FR Configurator2. · Interface: conforms to USB 1.1 · Transmission Speed: 12 Mbps · Connector: USB mini B connector (receptacle mini B type)			

*1 Terminal functions can be selected using Pr.178, Pr.179 (Input terminal function selection).

*2 Do not connect the parameter unit. The inverter may be damaged.

*3 USB bus power connection is available. The maximum SCCR should be 500 mA.

Example Connections

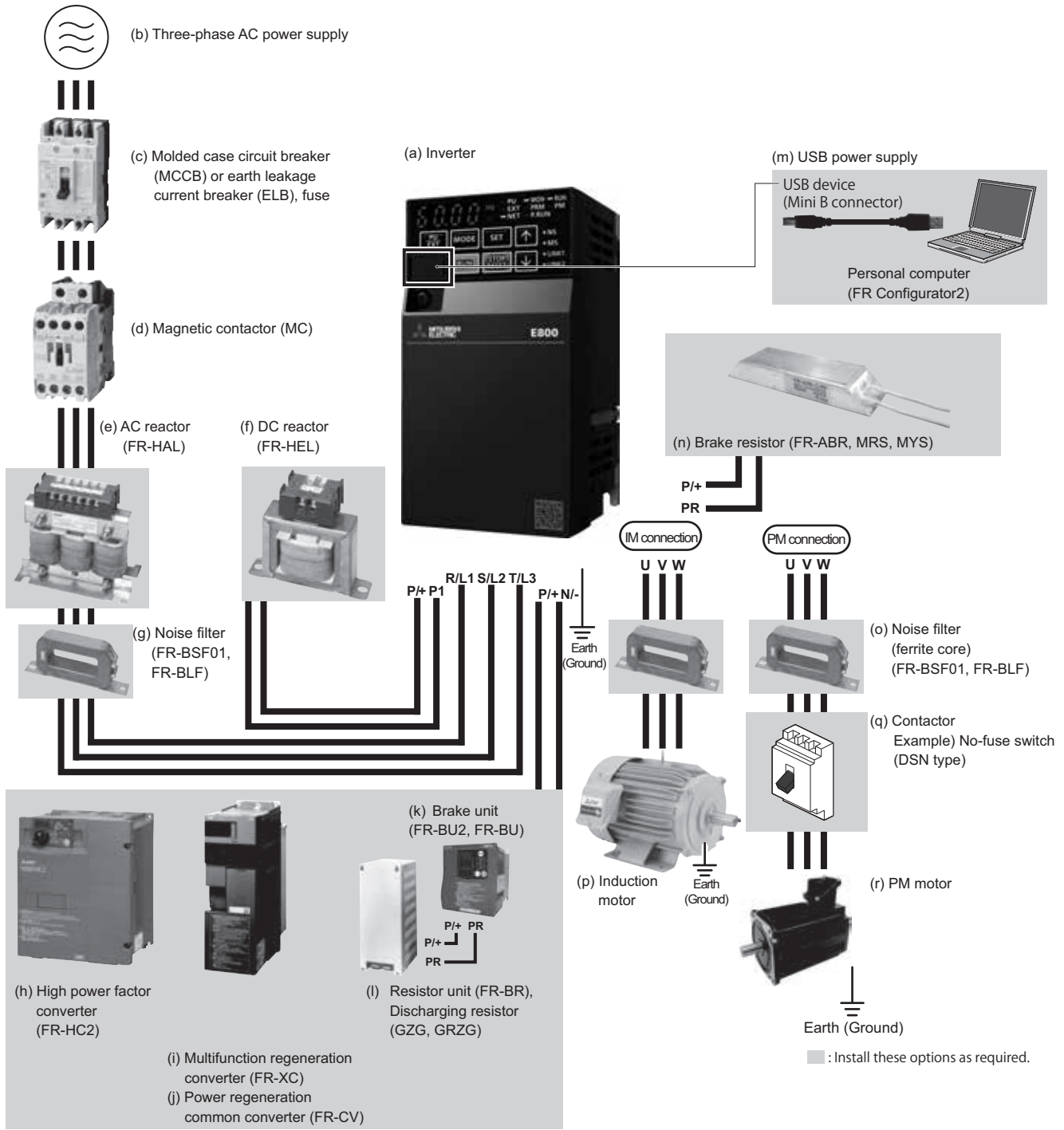

7

Example Connections

Symbol	Name	Overview
(a)	Inverter (FR-E800)	The life of the inverter is influenced by the surrounding air temperature. The surrounding air temperature should be as low as possible within the permissible range. This must be noted especially when the inverter is installed in an enclosure. Incorrect wiring may lead to damage of the inverter. The control signal lines must be kept fully away from the main circuit lines to protect them from noise.
(b)	Three-phase AC power supply	Must be within the permissible power supply specifications of the inverter.
(c)	Molded case circuit breaker (MCCB), earth leakage circuit breaker (ELB), or fuse	Must be selected carefully since an inrush current flows in the inverter at power ON.
(d)	Magnetic contactor (MC)	Install this to ensure safety. Do not use this to start and stop the inverter. Doing so will shorten the life of the inverter.
(e)	AC reactor (FR-HAL)	Install this to suppress harmonics and to improve the power factor. An AC reactor (FR-HAL) (option) is required when installing the inverter near a large power supply system (500 kVA or more). Under such condition, the inverter may be damaged if you do not use a reactor. Select a reactor according to the applied motor capacity.
(f)	DC reactor (FR-HEL)	Install this to suppress harmonics and to improve the power factor. Select a reactor according to the applied motor capacity. When using a DC reactor, remove the jumper across terminals P/+ and P1 before connecting a DC reactor to the inverter.
(g)	Noise filter (FR-BLF)	Install this to reduce the electromagnetic noise generated from the inverter.
(h)	High power factor converter (FR-HC2)	Suppresses the power supply harmonics significantly. Install this as required.
(i)	Multifunction regeneration converter (FR-XC)	
(j)	Power regeneration common converter (FR-CV)	Provides a large braking capability. Install this as required.
(k)	Brake unit (FR-BU2)	
(l)	Resistor unit (FR-BR), discharge resistor (GZG, GRZG)	Allows the inverter to provide the optimal regenerative braking capability. Install this as required.
(m)	USB connection	Connect between the inverter and a personal computer with a USB (ver. 1.1) cable.
(n)	Brake resistor (FR-ABR, MRS, MYS)	Increases the braking capability. (0.4K or higher)
(o)	Noise filter (ferrite core) (FR-BSF01, FR-BLF)	Install this to reduce the electromagnetic noise generated from the inverter. The noise filter is effective in the range from about 0.5 to 5 MHz. A wire should be wound four turns at maximum.
(p)	Induction motor	Connect a squirrel-cage induction motor.
(q)	Example) No-fuse switch (DSN type)	Connect this for an application where a PM motor is driven by the load even while the inverter power is OFF. Do not open or close the contactor while the inverter is running (outputting).
(r)	PM motor	An IPM motor cannot be driven by the commercial power supply.

NOTE

- To prevent an electric shock, always earth (ground) the motor and inverter.
- Do not install a power factor correction capacitor, surge suppressor, or capacitor type filter on the inverter's output side. Doing so will cause the inverter shut off or damage the capacitor or surge suppressor. If any of the above devices is connected, immediately remove it. When installing a molded case circuit breaker on the output side of the inverter, contact the manufacturer of the molded case circuit breaker.
- Electromagnetic wave interference:
The input/output (main circuit) of the inverter includes high frequency components, which may interfere with the communication devices (such as AM radios) used near the inverter. Install the EMC filter to minimize interference.
- For details of options and peripheral devices, refer to the respective Instruction Manual.
- A PM motor cannot be driven by the commercial power supply.
- A PM motor is a motor with permanent magnets embedded inside. High voltage is generated at the motor terminals while the motor is running. Before closing the contactor at the output side, make sure that the inverter power is ON and the motor is stopped.

Options

● Option List

By fitting the following options to the inverter, the inverter is provided with more functions.

	Name	Type	Applications	Applicable Inverter			Remarks	
				E800	E800-E	E800-SCE		
Plug-in Type	Vector control Orientation control Encoder feedback control	FR-A8AP E kit	Vector control can be performed for encoder-equipped motors (induction motors). The main spindle can be stopped at a specified position (orientation) in combination with an encoder. The motor speed is sent back and the speed is maintained constant.	○	○	○	Shared among all models	
	16-bit digital input	FR-A8AX E kit	This input interface sets the high frequency accuracy of the inverter using an external BCD or binary digital signal. · BCD code 3 digits (maximum 999) · BCD code 4 digits (maximum 9999) · Binary 12 bits (maximum FFFH) · Binary 16 bits (maximum FFFFH)	●	●	○		
	Digital output Extension analog output	FR-A8AY E kit	This option provides the inverter with open collector outputs selected from among the standard output signals. This option adds 2 different signals that can be monitored such as the output frequency and output voltage. 20mADC or 10VDC meter can be connected.	●	●	○		
	Relay output	FR-A8AR E kit	Output any three output signals available with the inverter as standard from the relay contact terminals.	●	●	○		
	CC-Link communication	FR-A8NC E kit	This option allows the inverter to be operated or monitored or the parameter setting to be changed from a computer or programmable controller.	●	●	○		
	DeviceNet communication	FR-A8ND E kit		○	○	○		
	PROFIBUS-DP communication	FR-A8NP E kit		○	○	○		
Stand-alone type	Liquid crystal display operation panel	FR-LU08 (-01)	Graphical operation panel with liquid crystal display	○	-	-	Shared among all models	
	Parameter unit	FR-PU07	Interactive parameter unit with LCD display	○	-	-		
	Parameter unit with battery pack	FR-PU07BB (-L)	This parameter unit enables parameter setting without connecting the inverter to power supply.	○	-	-		
	Enclosure surface operation panel	FR-PA07	This operation panel enables inverter operation and monitoring of frequency, etc. from the enclosure surface	●	-	-		
	Parameter unit connection cable	FR-CB20[]	Cable for connection of operation panel or parameter unit [] indicates a cable length. (1m, 3m, 5m)	●	-	-		
	Encoder cable Mitsubishi Electric vector control dedicated motor (SFV5RU)	FR-V7CBL[]	Connection cable for the inverter and encoder for Mitsubishi Electric vector control dedicated motor (SFV5RU). [] indicates a cable length. (5m, 15m, 30m)	○	○	○		
	USB cable	MR-J3USBCBL3M Cable length: 3 m	Amplifier connector Mini B connector (5-pin) Personal computer connector A connector 	●	●	○		
	Intercompatibility attachment	FR-E7AT 01/02/03	For installation of a FR-E800 series inverter to the installation holes of FR-A024/A044 series inverter.	●	●	○		3.7K or lower. The option's model varies with the inverter's model.
	Intercompatibility attachment	FR-E8AT03	For installation of a FR-E700/E800 inverter to the installation holes of FR-A024/A044/E700 inverter.	●	●	○		3.7K
	DIN rail attachment	FR-UDA 01 to 03	Attachment for installation on DIN rail	○	○	○		3.7K or lower. The option's model varies with the inverter's model.
	Panel through attachment	FR-E8CN 01 to 06	Using this attachment dissipates the inverter's heat by having the inverter heatsink protrude from the back side of the enclosure.	○	○	○		All capacities. The option's model varies with the inverter's model.
	Totally enclosed structure specification attachment (IP40)	FR-E8CV 01 to 04	Installing the attachment to the inverter changes the protective structure of the inverter to the totally enclosed structure (IP40 equivalent as specified by JEM1030).	○	○	○		
	AC reactor	FR-HAL	For harmonic current reduction and inverter input power factor improvement	●	●	○		
	DC reactor	FR-HEL		●	●	○		
	EMC Directive compliant noise filter	SF, FR-E5NF, FR-S5NFSA	EMC Directive (EN 61800-3 C3) compliant noise filter	●	●	○		
EMC compliant EMC filter installation attachment	FR-A5AT03 FR-AAT02 FR-E5T(-02)	For installation of the inverter to the EMC Directive compliant EMC filter (SF).	●	●	○	All capacities.		
Radio noise filter	FR-BIF(H)	For radio noise reduction (connect to the input side)	●	●	○			
Line noise filter	FR-BSF01, FR-BLF	For line noise reduction	●	●	○	All capacities.		

●: Supported ○: To be supported soon -: Not supported



Name	Type	Applications	Applicable Inverter			Remarks	
			E800	E800-E	E800-SCE		
Stand-alone type	Filterpack	FR-BFP2	Combination of power factor improving DC reactor, common mode choke, and capacitive filter	○	○	○	0.4K or higher of the three-phase power input model. The option's model varies with the inverter's model.
	Brake resistor	MRS type, MYS type	For increasing the regenerative braking capability (permissible duty 3%ED)	●	●	○	0.4K or higher. The option's model varies with the inverter's model.
	High-duty brake resistor	FR-ABR	For increasing the regenerative braking capability (permissible duty 10%/6%ED)	●	●	○	
	Brake unit, Resistor unit, Discharging resistor	FR-BU2, FR-BR, GZG, GRZG type	For increasing the braking capability of the inverter (for high-inertia load or negative load) Brake unit, electrical-discharge resistor and resistor unit are used in combination	●	●	○	
	Multifunction regeneration converter Dedicated stand-alone reactor Dedicated box-type reactor	FR-XC FR-XCL FR-XCB	One inverter can handle harmonic suppression and power regeneration. Functions that match the application can be selected by combining the inverter/converter with the dedicated reactor FR-XCB (box-type) or FR-XCL.	●	●	-	According to capacities
	High power factor converter	FR-HC2	The high power factor converter switches the converter section on/off to reshape an input current waveform into a sine wave, greatly suppressing harmonics. (Used in combination with the standard accessory.)	●	●	-	
	Surge voltage suppression filter	FR-ASF FR-BMF	Filter for suppressing surge voltage on motor	●	●	○	400V: According to capacities 400V: 5.5K or higher According to capacities
Others	Pilot generator	QVAH-10	For tracking operation. 70 V / 35 VAC 500 Hz (at 2500 r/min)	●	●	○	Shared among all models
	Deviation sensor	YVGC-500WNS	For continuous speed control operation (mechanical deviation detection) Output 90VAC /90°	●	●	○	
	Analog frequency meter (64mm × 60mm)	YM-206NRI 1mA	Dedicated frequency meter (graduated to 130 Hz). Moving-coil type DC ammeter	●	-	-	
	Calibration resistor	RV24YN 10kΩ	For frequency meter calibration. Carbon film type B characteristic	●	●	○	
	FR Configurator2 (Inverter setup software)	SW1DND-FRC2	Supports an inverter startup to maintenance.	●	●	○	
	FR Configurator Mobile (Mobile App for Inverters)	-	The app enables operation of inverters using smart phones or tablets.	○	○	○	

●: Supported ○: To be supported soon -: Not supported

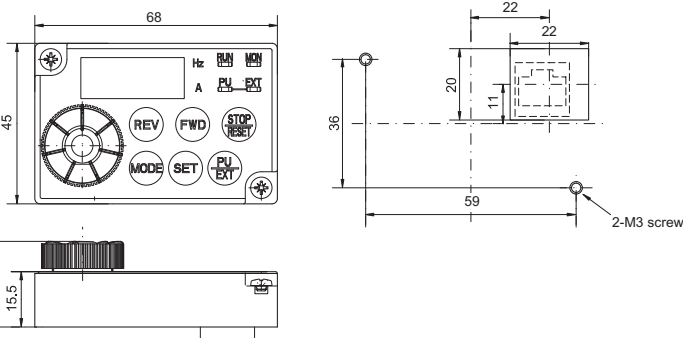
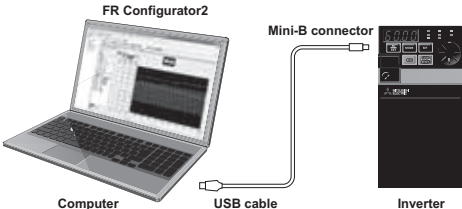
● Stand-alone option

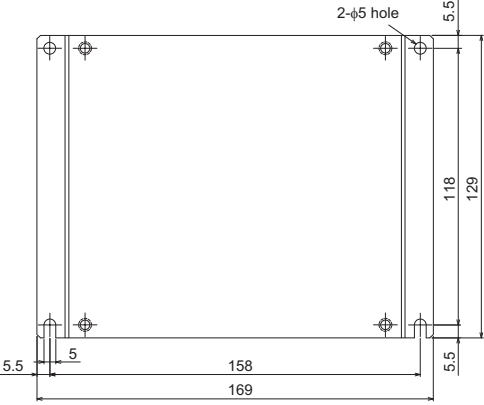

Name (model)	Specification and structure								
<p>Enclosure surface operation panel FR-PA07</p>	<p>This operation panel can be mounted to an enclosure surface to enable inverter operation and monitoring of frequency, etc. (This product does not have the parameter copy function.)</p> <ul style="list-style-type: none"> Outline dimension (Unit: mm) 								
<p>Parameter unit connection cable FR-CB20[]</p>	<p>This cable is for connection of operation panel or parameter unit</p> <ul style="list-style-type: none"> Specifications <table border="1" data-bbox="400 763 703 887"> <thead> <tr> <th>Model</th> <th>Length</th> </tr> </thead> <tbody> <tr> <td>FR-CB201</td> <td>1m</td> </tr> <tr> <td>FR-CB203</td> <td>3m</td> </tr> <tr> <td>FR-CB205</td> <td>5m</td> </tr> </tbody> </table>	Model	Length	FR-CB201	1m	FR-CB203	3m	FR-CB205	5m
Model	Length								
FR-CB201	1m								
FR-CB203	3m								
FR-CB205	5m								
<p>USB cable MR-J3USBCBL3M</p>	<p>USB cable for communication with the inverter using the USB port of the PC.</p> 								

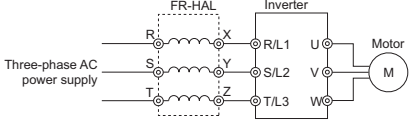
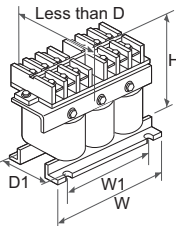
Name (model)	Specification and structure															
<p style="text-align: center;">Intercompatibility attachment FR-E7AT01/02/03</p>	<p>Intercompatibility attachment This attachment is used to install the FR-E700/FR-E800 series inverter using the installation holes of the FR-A024/FR-A044/FRE700 series inverter. (The depth increases after installation of the inverter when the attachment is used.)</p> <ul style="list-style-type: none"> Replacing the FR-A024/FR-A044 inverter with the FR-E820/FR-E840 inverter 															
	<table border="1" style="width: 100%; border-collapse: collapse;"> <thead> <tr> <th style="width: 15%;">Compatible Former Model</th> <th style="width: 15%;">Mountable Model</th> <th style="width: 15%;">Intercompatibility Attachment</th> </tr> </thead> <tbody> <tr> <td rowspan="3" style="text-align: center;">FR-A024</td> <td>0.1K to 0.75K</td> <td>0008 (0.1K) to 0050 (0.75K)</td> </tr> <tr> <td>1.5K</td> <td>0080 (1.5K)</td> </tr> <tr> <td>2.2K, 3.7K</td> <td>0110 (2.2K), 0175 (3.7K)</td> </tr> <tr> <td rowspan="2" style="text-align: center;">FR-A044</td> <td>0.4K, 0.75K</td> <td>0016 (0.4K), 0026 (0.75K)</td> </tr> <tr> <td>1.5K to 3.7K</td> <td>0040 (1.5K) to 0095 (3.7K)</td> </tr> </tbody> </table>	Compatible Former Model	Mountable Model	Intercompatibility Attachment	FR-A024	0.1K to 0.75K	0008 (0.1K) to 0050 (0.75K)	1.5K	0080 (1.5K)	2.2K, 3.7K	0110 (2.2K), 0175 (3.7K)	FR-A044	0.4K, 0.75K	0016 (0.4K), 0026 (0.75K)	1.5K to 3.7K	0040 (1.5K) to 0095 (3.7K)
	Compatible Former Model	Mountable Model	Intercompatibility Attachment													
	FR-A024	0.1K to 0.75K	0008 (0.1K) to 0050 (0.75K)													
		1.5K	0080 (1.5K)													
		2.2K, 3.7K	0110 (2.2K), 0175 (3.7K)													
	FR-A044	0.4K, 0.75K	0016 (0.4K), 0026 (0.75K)													
		1.5K to 3.7K	0040 (1.5K) to 0095 (3.7K)													
	<ul style="list-style-type: none"> Replacing the FR-E740 inverter with the FR-E840 inverter <table border="1" style="width: 100%; border-collapse: collapse;"> <thead> <tr> <th style="width: 15%;">Compatible Former Model</th> <th style="width: 15%;">Mountable Model</th> <th style="width: 15%;">Intercompatibility Attachment</th> </tr> </thead> <tbody> <tr> <td rowspan="2" style="text-align: center;">FR-E740</td> <td>0.4K to 1.5K</td> <td>0016 (0.4K) to 0040 (1.5K)</td> </tr> <tr> <td>2.2K, 3.7K</td> <td>0060 (2.2K), 0095 (3.7K)</td> </tr> </tbody> </table>	Compatible Former Model	Mountable Model	Intercompatibility Attachment	FR-E740	0.4K to 1.5K	0016 (0.4K) to 0040 (1.5K)	2.2K, 3.7K	0060 (2.2K), 0095 (3.7K)							
	Compatible Former Model	Mountable Model	Intercompatibility Attachment													
FR-E740	0.4K to 1.5K	0016 (0.4K) to 0040 (1.5K)														
	2.2K, 3.7K	0060 (2.2K), 0095 (3.7K)														
<p>—: The attachment is not required.</p>																
<p>To replace the FR-E720 inverter with the FR-E820 inverter, use the FR-E8AT03</p>																
<p>• Outline dimension (Unit: mm)</p>																
<p>• FR-E7AT01</p>																
<p style="text-align: center;">(Unit: mm)</p>																
<p>• FR-E7AT03</p>																
<p style="text-align: center;">(Unit: mm)</p>																

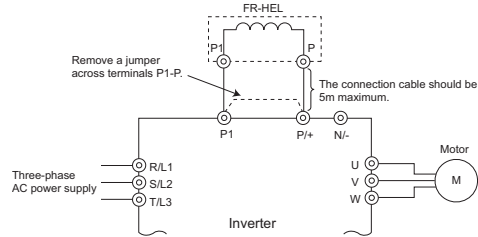
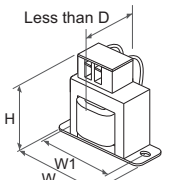
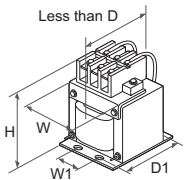
Name (model)	Specification and structure																																																																																																																																																																		
<p>Intercompatibility attachment FR-E8AT03</p>	<p>Intercompatibility attachment This attachment is used to install the FR-E800 series inverter using the installation holes of the FR-E700 series inverter. (The depth increases after installation of the inverter when the attachment is used.)</p> <ul style="list-style-type: none"> Replacing the FR-E720 inverter with the FR-E820 inverter <table border="1" data-bbox="359 324 1252 443"> <thead> <tr> <th>Compatible former model</th> <th>Mountable model</th> <th>Intercompatibility attachment</th> </tr> </thead> <tbody> <tr> <td rowspan="2">FR-E720</td> <td>0.1K to 2.2K</td> <td>FR-E820</td> </tr> <tr> <td>3.7K</td> <td>FR-E820</td> </tr> <tr> <td></td> <td>0.1K (0008) to 2.2K (0110)</td> <td>FR-E8AT03</td> </tr> <tr> <td></td> <td>3.7K (0175)</td> <td>FR-E8AT03</td> </tr> </tbody> </table> <p>—: The attachment is not required. To replace the FR-E740 inverter with the FR-E840 inverter, use the FR-E7AT02.</p> <ul style="list-style-type: none"> Outline dimension (Unit: mm) <ul style="list-style-type: none"> FR-E8AT03 	Compatible former model	Mountable model	Intercompatibility attachment	FR-E720	0.1K to 2.2K	FR-E820	3.7K	FR-E820		0.1K (0008) to 2.2K (0110)	FR-E8AT03		3.7K (0175)	FR-E8AT03																																																																																																																																																				
Compatible former model	Mountable model	Intercompatibility attachment																																																																																																																																																																	
FR-E720	0.1K to 2.2K	FR-E820																																																																																																																																																																	
	3.7K	FR-E820																																																																																																																																																																	
	0.1K (0008) to 2.2K (0110)	FR-E8AT03																																																																																																																																																																	
	3.7K (0175)	FR-E8AT03																																																																																																																																																																	
<p>AC reactor (for power supply coordination) FR-HAL</p> 	<p>Improves the power factor and reduces the harmonic current at the input side. Connect an AC reactor at the input side of the inverter.</p> <ul style="list-style-type: none"> Selection method Select an AC reactor according to the applied motor capacity. (Select the AC reactor according to the motor capacity even if the capacity is smaller than the inverter capacity.) Connection diagram  <ul style="list-style-type: none"> Outline dimension (Unit: mm) <table border="1" data-bbox="359 1344 869 1668"> <thead> <tr> <th>Model</th> <th>W</th> <th>W1</th> <th>H</th> <th>D</th> <th>D1</th> <th>d</th> <th>Mass (kg)</th> </tr> </thead> <tbody> <tr> <td rowspan="9">200V</td> <td>0.4K</td> <td>104</td> <td>84</td> <td>99</td> <td>72</td> <td>40</td> <td>M5</td> <td>0.6</td> </tr> <tr> <td>0.75K</td> <td>104</td> <td>84</td> <td>99</td> <td>74</td> <td>44</td> <td>M5</td> <td>0.8</td> </tr> <tr> <td>1.5K</td> <td>104</td> <td>84</td> <td>99</td> <td>77</td> <td>50</td> <td>M5</td> <td>1.1</td> </tr> <tr> <td>2.2K</td> <td>115</td> <td>40</td> <td>115</td> <td>77</td> <td>57</td> <td>M6</td> <td>1.5</td> </tr> <tr> <td>3.7K</td> <td>115</td> <td>40</td> <td>115</td> <td>83</td> <td>67</td> <td>M6</td> <td>2.2</td> </tr> <tr> <td>5.5K</td> <td>115</td> <td>40</td> <td>115</td> <td>83</td> <td>67</td> <td>M6</td> <td>2.3</td> </tr> <tr> <td>7.5K</td> <td>130</td> <td>50</td> <td>135</td> <td>100</td> <td>86</td> <td>M6</td> <td>4.2</td> </tr> <tr> <td>11K</td> <td>160</td> <td>75</td> <td>164</td> <td>111</td> <td>92</td> <td>M6</td> <td>5.2</td> </tr> <tr> <td>15K</td> <td>160</td> <td>75</td> <td>167</td> <td>126</td> <td>107</td> <td>M6</td> <td>7.0</td> </tr> </tbody> </table> <table border="1" data-bbox="901 1332 1412 1657"> <thead> <tr> <th>Model</th> <th>W</th> <th>W1</th> <th>H</th> <th>D</th> <th>D1</th> <th>d</th> <th>Mass (kg)</th> </tr> </thead> <tbody> <tr> <td rowspan="10">400V</td> <td>H0.4K</td> <td>135</td> <td>120</td> <td>115</td> <td>64</td> <td>45</td> <td>M4</td> <td>1.5</td> </tr> <tr> <td>H0.75K</td> <td>135</td> <td>120</td> <td>115</td> <td>64</td> <td>45</td> <td>M4</td> <td>1.5</td> </tr> <tr> <td>H1.5K</td> <td>135</td> <td>120</td> <td>115</td> <td>64</td> <td>45</td> <td>M4</td> <td>1.5</td> </tr> <tr> <td>H2.2K</td> <td>135</td> <td>120</td> <td>115</td> <td>64</td> <td>45</td> <td>M4</td> <td>1.5</td> </tr> <tr> <td>H3.7K</td> <td>135</td> <td>120</td> <td>115</td> <td>74</td> <td>57</td> <td>M4</td> <td>2.5</td> </tr> <tr> <td>H5.5K</td> <td>160</td> <td>145</td> <td>142</td> <td>76</td> <td>55</td> <td>M4</td> <td>3.5</td> </tr> <tr> <td>H7.5K</td> <td>160</td> <td>145</td> <td>142</td> <td>96</td> <td>75</td> <td>M4</td> <td>5.0</td> </tr> <tr> <td>H11K</td> <td>160</td> <td>145</td> <td>146</td> <td>96</td> <td>75</td> <td>M4</td> <td>6.0</td> </tr> <tr> <td>H15K</td> <td>220</td> <td>200</td> <td>195</td> <td>105</td> <td>70</td> <td>M5</td> <td>9.0</td> </tr> </tbody> </table> <ul style="list-style-type: none"> (a) Approximately 88% of the power factor improving effect can be obtained (92.3% when calculated with 1 power factor for the fundamental wave according to the Architectural Standard Specifications (Electrical Installation) (2013 revision) supervised by the Ministry of Land, Infrastructure, Transport and Tourism of Japan). (b) This is a sample outline dimension drawing. The shape differs by the model. W1 and D1 indicate distances between installation holes. The installation hole size is indicated by d. (c) When installing an AC reactor (FR-HAL), install in the orientation shown below. (H)55K or lower: Horizontal installation or vertical installation (H)75K or higher: Horizontal installation (d) Keep enough clearance around the reactor because it heats up. (Keep a clearance of minimum 10cm each on top and bottom and minimum 5cm each on right and left regardless of the installation orientation.) 	Model	W	W1	H	D	D1	d	Mass (kg)	200V	0.4K	104	84	99	72	40	M5	0.6	0.75K	104	84	99	74	44	M5	0.8	1.5K	104	84	99	77	50	M5	1.1	2.2K	115	40	115	77	57	M6	1.5	3.7K	115	40	115	83	67	M6	2.2	5.5K	115	40	115	83	67	M6	2.3	7.5K	130	50	135	100	86	M6	4.2	11K	160	75	164	111	92	M6	5.2	15K	160	75	167	126	107	M6	7.0	Model	W	W1	H	D	D1	d	Mass (kg)	400V	H0.4K	135	120	115	64	45	M4	1.5	H0.75K	135	120	115	64	45	M4	1.5	H1.5K	135	120	115	64	45	M4	1.5	H2.2K	135	120	115	64	45	M4	1.5	H3.7K	135	120	115	74	57	M4	2.5	H5.5K	160	145	142	76	55	M4	3.5	H7.5K	160	145	142	96	75	M4	5.0	H11K	160	145	146	96	75	M4	6.0	H15K	220	200	195	105	70	M5	9.0
Model	W	W1	H	D	D1	d	Mass (kg)																																																																																																																																																												
200V	0.4K	104	84	99	72	40	M5	0.6																																																																																																																																																											
	0.75K	104	84	99	74	44	M5	0.8																																																																																																																																																											
	1.5K	104	84	99	77	50	M5	1.1																																																																																																																																																											
	2.2K	115	40	115	77	57	M6	1.5																																																																																																																																																											
	3.7K	115	40	115	83	67	M6	2.2																																																																																																																																																											
	5.5K	115	40	115	83	67	M6	2.3																																																																																																																																																											
	7.5K	130	50	135	100	86	M6	4.2																																																																																																																																																											
	11K	160	75	164	111	92	M6	5.2																																																																																																																																																											
	15K	160	75	167	126	107	M6	7.0																																																																																																																																																											
Model	W	W1	H	D	D1	d	Mass (kg)																																																																																																																																																												
400V	H0.4K	135	120	115	64	45	M4	1.5																																																																																																																																																											
	H0.75K	135	120	115	64	45	M4	1.5																																																																																																																																																											
	H1.5K	135	120	115	64	45	M4	1.5																																																																																																																																																											
	H2.2K	135	120	115	64	45	M4	1.5																																																																																																																																																											
	H3.7K	135	120	115	74	57	M4	2.5																																																																																																																																																											
	H5.5K	160	145	142	76	55	M4	3.5																																																																																																																																																											
	H7.5K	160	145	142	96	75	M4	5.0																																																																																																																																																											
	H11K	160	145	146	96	75	M4	6.0																																																																																																																																																											
	H15K	220	200	195	105	70	M5	9.0																																																																																																																																																											

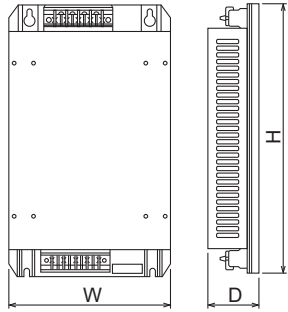
Name (model)	Specification and structure																																																																																																																																																											
<p style="text-align: center;">DC reactor (for power supply coordination) FR-HEL-(H)□K</p> 	<p>Improves the power factor and reduces the harmonic current at the input side.</p> <p>Selection method Select a DC reactor according to the applied motor capacity. (Select it according to the motor capacity even if the capacity is smaller than the inverter capacity.) (Refer to page 98)</p> <p>• Connection diagram Connect a DC reactor to the inverter terminals P1 and P. Remove the jumper across terminals P1 and P. If the jumper is left attached, no power factor improvement can be obtained. The connection cable between the reactor and the inverter should be as short as possible (5m or less).</p>  <p>• Outline dimension (Unit: mm)</p> <div style="display: flex; justify-content: space-around;"> <div data-bbox="438 582 614 817">  <p style="text-align: center;">FR-HEL-0.4K to 2.2K FR-HEL-H0.4K</p> </div> <div data-bbox="790 582 981 817">  <p style="text-align: center;">FR-HEL-3.7K to 55K FR-HEL-H0.75K to H55K</p> </div> </div> <table border="1" style="width: 100%; border-collapse: collapse; text-align: center;"> <thead> <tr> <th></th> <th>Model</th> <th>W</th> <th>W1</th> <th>H</th> <th>D</th> <th>D1</th> <th>d</th> <th>Mass (kg)</th> </tr> </thead> <tbody> <tr> <td rowspan="9" style="writing-mode: vertical-rl; transform: rotate(180deg);">200V</td> <td>0.4K</td> <td>70</td> <td>60</td> <td>71</td> <td>61</td> <td>—</td> <td>M4</td> <td>0.4</td> </tr> <tr> <td>0.75K</td> <td>85</td> <td>74</td> <td>81</td> <td>61</td> <td>—</td> <td>M4</td> <td>0.5</td> </tr> <tr> <td>1.5K</td> <td>85</td> <td>74</td> <td>81</td> <td>70</td> <td>—</td> <td>M4</td> <td>0.8</td> </tr> <tr> <td>2.2K</td> <td>85</td> <td>74</td> <td>81</td> <td>70</td> <td>—</td> <td>M4</td> <td>0.9</td> </tr> <tr> <td>3.7K</td> <td>77</td> <td>55</td> <td>92</td> <td>82</td> <td>57</td> <td>M4</td> <td>1.5</td> </tr> <tr> <td>5.5K</td> <td>77</td> <td>55</td> <td>92</td> <td>92</td> <td>67</td> <td>M4</td> <td>1.9</td> </tr> <tr> <td>7.5K</td> <td>86</td> <td>60</td> <td>113</td> <td>98</td> <td>72</td> <td>M4</td> <td>2.5</td> </tr> <tr> <td>11K</td> <td>105</td> <td>64</td> <td>133</td> <td>112</td> <td>79</td> <td>M6</td> <td>3.3</td> </tr> <tr> <td>15K</td> <td>105</td> <td>64</td> <td>133</td> <td>115</td> <td>84</td> <td>M6</td> <td>4.1</td> </tr> <tr> <td rowspan="9" style="writing-mode: vertical-rl; transform: rotate(180deg);">400V</td> <td>H0.4K</td> <td>90</td> <td>75</td> <td>78</td> <td>60</td> <td>—</td> <td>M5</td> <td>0.6</td> </tr> <tr> <td>H0.75K</td> <td>66</td> <td>50</td> <td>100</td> <td>70</td> <td>48</td> <td>M4</td> <td>0.8</td> </tr> <tr> <td>H1.5K</td> <td>66</td> <td>50</td> <td>100</td> <td>80</td> <td>54</td> <td>M4</td> <td>1</td> </tr> <tr> <td>H2.2K</td> <td>76</td> <td>50</td> <td>110</td> <td>80</td> <td>54</td> <td>M4</td> <td>1.3</td> </tr> <tr> <td>H3.7K</td> <td>86</td> <td>55</td> <td>120</td> <td>95</td> <td>69</td> <td>M4</td> <td>2.3</td> </tr> <tr> <td>H5.5K</td> <td>96</td> <td>60</td> <td>128</td> <td>100</td> <td>75</td> <td>M5</td> <td>3</td> </tr> <tr> <td>H7.5K</td> <td>96</td> <td>60</td> <td>128</td> <td>105</td> <td>80</td> <td>M5</td> <td>3.5</td> </tr> <tr> <td>H11K</td> <td>105</td> <td>75</td> <td>137</td> <td>110</td> <td>85</td> <td>M5</td> <td>4.5</td> </tr> <tr> <td>H15K</td> <td>105</td> <td>75</td> <td>152</td> <td>125</td> <td>95</td> <td>M5</td> <td>5</td> </tr> </tbody> </table> <p>(a) The size of the cables used should be equal to or larger than that of the power supply cables (R/L1, S/L2, T/L3). (Refer to page 90)</p> <p>(b) Approximately 93% of the power factor improving effect can be obtained (94.4% when calculated with 1 power factor for the fundamental wave according to the Architectural Standard Specifications (Electrical Installation) (2010 revision) supervised by the Ministry of Land, Infrastructure, Transport and Tourism of Japan).</p> <p>(c) This is a sample outline dimension drawing. The shape differs by the model. W1 and D1 indicate distances between installation holes. The installation hole size is indicated by d.</p> <p>(d) When installing a DC reactor (FR-HEL), install in the orientation shown below. (H)55K or lower: Horizontal installation or vertical installation (H)75K or higher: Horizontal installation</p> <p>(e) Keep enough clearance around the reactor because it heats up. (Keep a clearance of minimum 10cm each on top and bottom and minimum 5cm each on right and left regardless of the installation orientation.)</p>		Model	W	W1	H	D	D1	d	Mass (kg)	200V	0.4K	70	60	71	61	—	M4	0.4	0.75K	85	74	81	61	—	M4	0.5	1.5K	85	74	81	70	—	M4	0.8	2.2K	85	74	81	70	—	M4	0.9	3.7K	77	55	92	82	57	M4	1.5	5.5K	77	55	92	92	67	M4	1.9	7.5K	86	60	113	98	72	M4	2.5	11K	105	64	133	112	79	M6	3.3	15K	105	64	133	115	84	M6	4.1	400V	H0.4K	90	75	78	60	—	M5	0.6	H0.75K	66	50	100	70	48	M4	0.8	H1.5K	66	50	100	80	54	M4	1	H2.2K	76	50	110	80	54	M4	1.3	H3.7K	86	55	120	95	69	M4	2.3	H5.5K	96	60	128	100	75	M5	3	H7.5K	96	60	128	105	80	M5	3.5	H11K	105	75	137	110	85	M5	4.5	H15K	105	75	152	125	95	M5	5
	Model	W	W1	H	D	D1	d	Mass (kg)																																																																																																																																																				
200V	0.4K	70	60	71	61	—	M4	0.4																																																																																																																																																				
	0.75K	85	74	81	61	—	M4	0.5																																																																																																																																																				
	1.5K	85	74	81	70	—	M4	0.8																																																																																																																																																				
	2.2K	85	74	81	70	—	M4	0.9																																																																																																																																																				
	3.7K	77	55	92	82	57	M4	1.5																																																																																																																																																				
	5.5K	77	55	92	92	67	M4	1.9																																																																																																																																																				
	7.5K	86	60	113	98	72	M4	2.5																																																																																																																																																				
	11K	105	64	133	112	79	M6	3.3																																																																																																																																																				
	15K	105	64	133	115	84	M6	4.1																																																																																																																																																				
400V	H0.4K	90	75	78	60	—	M5	0.6																																																																																																																																																				
	H0.75K	66	50	100	70	48	M4	0.8																																																																																																																																																				
	H1.5K	66	50	100	80	54	M4	1																																																																																																																																																				
	H2.2K	76	50	110	80	54	M4	1.3																																																																																																																																																				
	H3.7K	86	55	120	95	69	M4	2.3																																																																																																																																																				
	H5.5K	96	60	128	100	75	M5	3																																																																																																																																																				
	H7.5K	96	60	128	105	80	M5	3.5																																																																																																																																																				
	H11K	105	75	137	110	85	M5	4.5																																																																																																																																																				
	H15K	105	75	152	125	95	M5	5																																																																																																																																																				

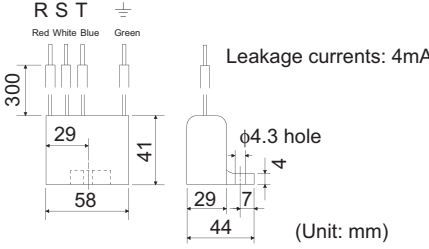
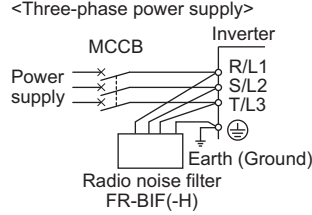
Name (model)	Specification and structure								
<p>EMC Directive compliant EMC filter SF, FR-E5NF</p> <p>EMC compliant EMC filter installation attachment FR-E5T(-02)</p>	<p>• The EMC compliant EMC filter (EN61800-3 2nd Environment Category C3) is a filter compliant with the EU EMC Directive (EN61800-3 2nd Environment Category C3).</p> 								
	EMC filter Model	Applicable inverter model	Intercompatibility attachment *1	Outline dimension (Unit: mm)			Mass (kg)	Leakage current (mA) *2 (reference value)	Loss (W)
				W	H	D			
	SF1306	FR-E820-0.1K to 1.5K	-	110	200	36.5	0.7	10	7.3
	SF1309	FR-E820-2.2K	FR-E5T	200	282	57	2.1	15	15
		FR-E820-3.7K	FR-E8AT03 FR-E5T						
	FR-E5NF-H0.75K	FR-E840-0.4K, 0.75K	FR-E7AT02	140	210	46	1.1	22.6	5.5
	FR-E5NF-H3.7K	FR-E840-1.5K	FR-E7AT02	140	210	46	1.2	44.5	8
		FR-E840-2.2K, 3.7K	-						
	FR-E5NF-H7.5K	FR-E840-5.5K, 7.5K	-	220	210	47	2	68.4	15
			W	H	D	D1			
			W	H	D	D1			
EMC filter Model	Applicable inverter model	Intercompatibility attachment *1	Outline dimension (Unit: mm)				Mass (kg)	Leakage current (mA) *2 (reference value)	Loss (W)
			W	H	D	D1			
SF1260	FR-E820-5.5K, 7.5K	FR-E5T-02	222	468	80	39	5	440	118
<p>*1 Depth is 12mm deeper when an intercompatibility attachment is installed.</p> <p>*2 Leakage current for one phase of three-phase three-wire star-connection power supply. Leakage current for all phases of three-phase three-wire delta-connection power supply is three times greater than the indicated value.</p> <p>This is a sample outline dimension drawing. The shape differs by the model.</p> <p>• Countermeasures for leakage current</p> <p>Take the following actions to prevent malfunction of peripheral devices or an electric shock caused by leakage current.</p> <p>(a) Earth (ground) the EMC filter before connecting the power supply. When doing so, confirm that earthing (grounding) is securely performed through the earthing (grounding) part of the enclosure.</p> <p>(b) Select an appropriate earth leakage circuit breaker or an earth leakage relay by considering leakage current of the EMC filter. Note that earth leakage circuit breaker may not be used in some cases such as when leakage current of the EMC filter is too large. In that case, use an earth leakage relay with high sensitivity. When both of earth leakage circuit breaker and earth leakage relay cannot be used, securely earth (ground) as explained in (a).</p>									

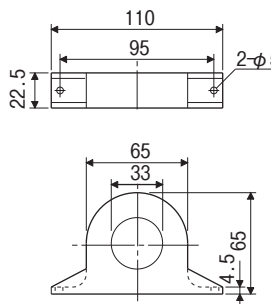
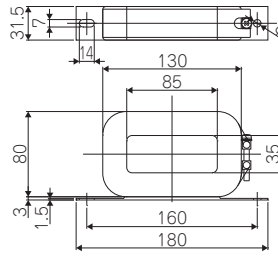
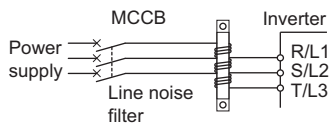
Name (model)	Specification and structure
<p>Radio noise filter FR-BIF(H)</p> 	<p>• Outline dimension</p>  <p>Leakage currents: 4mA</p> <p>(Unit: mm)</p> <p>(a) Cannot be connected to the inverter output side. (b) The wire should be cut as short as possible, and connected to the inverter terminal block.</p>  <p><Three-phase power supply></p> <p>Power supply: R, S, T (Red, White, Blue)</p> <p>MCCB</p> <p>Inverter: R/L1, S/L2, T/L3</p> <p>Earth (Ground)</p> <p>Radio noise filter FR-BIF(-H)</p>
<p>Line noise filter FR-BSF01, FR-BLF</p> 	<p>Install an EMC filter (ferrite core) to reduce the electromagnetic noise generated from the inverter. Effective in the range from about 0.5 MHz to 5 MHz. range from about 0.5 MHz to 5 MHz.</p> <p>• Outline dimension (Unit: mm)</p> <div style="display: flex; justify-content: space-around;"> <div data-bbox="399 638 718 974"> <p>FR-BSF01</p>  </div> <div data-bbox="734 638 1053 929"> <p>FR-BLF</p>  </div> </div> <p>(a) Wind each phase for three times (4T) in the same direction. (The greater the number of turns, the more effective result is obtained.) When using several line noise filters to make 4T or more, wind the phases (cables) together. Do not use a different line noise filter for different phases.</p> <p>(b) When the cables are too thick to be wound, run each cable (phase) through four or more filters installed in series in one direction.</p> <p>(c) The filter can be used in the same way as the output side. When using filters at the output side, do not wind the cable more than 3 times (4T) for each filter because the filter may overheat.</p> <p>(d) A thick cable of 38 mm² or more is not applicable to the FR-BSF01. Use FR-BLF for a larger diameter cable.</p> <p>(e) Do not wind the earthing (grounding) cable.</p>  <p>Power supply</p> <p>MCCB</p> <p>Line noise filter</p> <p>Inverter: R/L1, S/L2, T/L3</p>

Filterpack FR-BFP2



Name (model)

Specification and structure

- Using the option, the inverter may conform to the Japanese guideline for reduction of harmonic emission.
- The option is available for three-phase 200V/400V class inverters with 0.4K to 15K capacity.

• Specification

- Three-phase 200V pow input model

Model FR-BFP2-□K	0.4	0.75	1.5	2.2	3.7	5.5	7.5	11	15
Permissible inverter output current (A) *1	2.5	4.2	7	10	16.5	23.8	31.8	45	58
Approximate mass (kg)	1.3	1.4	2.0	2.2	2.8	3.8	4.5	6.7	7.0

Power factor improving reactor Install a DC reactor on the DC side.
93% to 95% of power supply power factor under 100% load (94.4% *3)

Noise filter **Common mode choke** Install a ferrite core on the input side.

Capacitive filter About 4mA of capacitor leakage current *2

Protective structure (JEM1030) Open type (IP00)

- Three-phase 400V power input mode

Model FR-BFP2-H□K	0.4	0.75	1.5	2.2	3.7	5.5	7.5	11	15
Permissible inverter output current (A) *1	1.2	2.2	3.7	5	8.1	12	16.3	23	29.5
Approximate mass (kg)	1.6	1.7	1.9	2.3	2.6	4.5	5.0	7.0	8.2

Power factor improving reactor Install a DC reactor on the DC side.
93% to 95% of power supply power factor under 100% load (94.4% *3)

Noise filter **Common mode choke** Install a ferrite core on the input side.

Capacitive filter About 8mA of capacitor leakage current *2

Protective structure (JEM1030) Open type (IP00)

- *1 Select a capacity for the load (inverter output) current to be equal to or less than the permissible inverter output current.
- *2 The indicated leakage current is for one phase of the three-phase three-wire star-connection power supply.
- *3 The values in parentheses are calculated with 1 fundamental frequency power factor according to the Year 2013 Standard specification for public constructions (electric installation works), published by the Ministry of Land, Infrastructure, Transport and Tourism in Japan.

• Outline dimension (Unit: mm)

<FR-BFP2-0.4K, 0.75K, 1.5K, 2.2K, 3.7K>
<FR-BFP2-H0.4K, H0.75K, H1.5K, H2.2K, H3.7K>

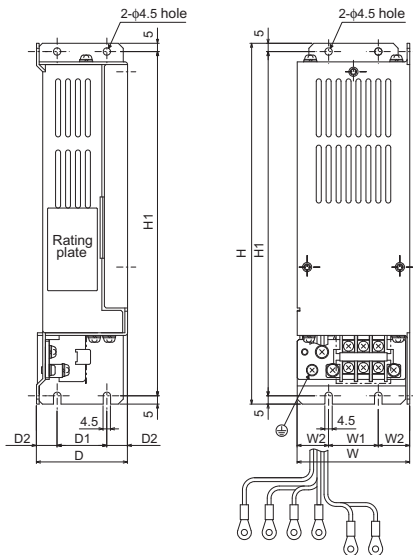

<FR-BFP2-5.5K, 7.5K, 11K, 15K>
<FR-BFP2-H5.5K, H7.5K, H11K, H15K>

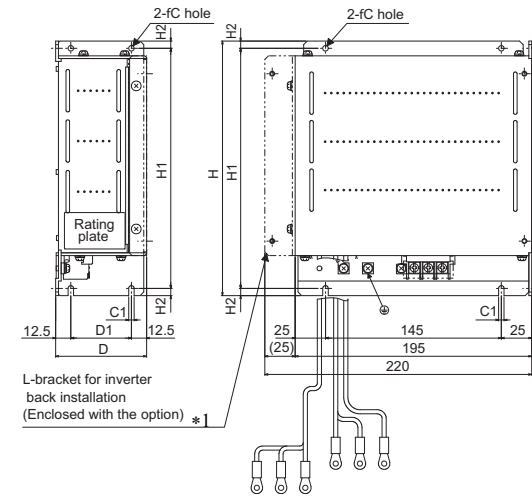

	Capacity	Dimensions (mm)							
		W	W1	W2	H	H1	D	D1	D2
200V	0.4K, 0.75K	68	30	19	218	208	60	30	15
	1.5K, 2.2K	108	55	26.5	188	178	80	55	12.5
	3.7K	170	120	25	188	178	65	40	12.5
	H0.4K, H0.75K*1	108	55	26.5	188	178	55	30	12.5
400V	H1.5K, H2.2K, H3.7K	108	55	26.5	188	178	80	55	12.5

	Capacity	Dimensions (mm)							
		H	H1	H2	D	D1	C	C1	C2
200V	5.5K, 7.5K	210	198	6	75	50	4.5	4.5	5.3
	11K	320	305	7.5	85	60	6	6	5.3
	15K	320	305	7.5	85	60	6	6	6.4
400V	H5.5K, H7.5K	210	198	6	75	50	4.5	4.5	4.3
	H11K	320	305	7.5	85	60	6	6	4.3
	H15K	320	305	7.5	85	60	6	6	6.4

*1 L-bracket is not attached when shipped from the factory but is enclosed with the option. L-bracket is required to install the option to the back of inverter.

(a) Above outline dimension drawings are examples. Dimensions differ by model.

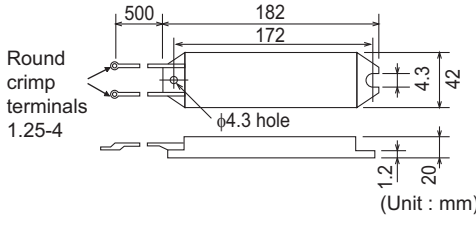
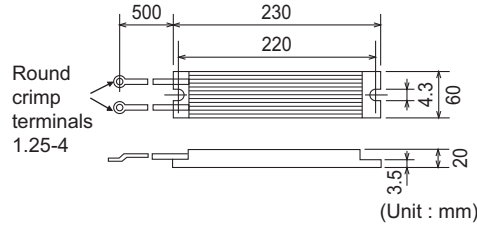
Name (model)	Specification and structure																														
<p style="text-align: center;">Brake resistor MRS type, MYS type</p>	<p>• Outline dimension</p> <div style="display: flex; justify-content: space-around;"> <div data-bbox="399 280 877 537"> <p>• MRS type</p>  </div> <div data-bbox="941 280 1420 537"> <p>• MYS type</p>  </div> </div>																														
	<table border="1" style="width: 100%; border-collapse: collapse; text-align: center;"> <thead> <tr> <th colspan="2" style="text-align: left;">Resistor Model</th> <th style="text-align: left;">Control torque / permissible duty</th> <th style="text-align: left;">Resistance Value (Ω)</th> <th style="text-align: left;">Permissible Power (W)</th> <th style="text-align: left;">Applicable Motor Capacity (kW)</th> </tr> </thead> <tbody> <tr> <td rowspan="5" style="vertical-align: middle; font-weight: bold;">200V</td> <td rowspan="4" style="vertical-align: middle; font-weight: bold;">MRS type</td> <td>MRS120W200</td> <td>200</td> <td>15</td> <td>0.4</td> </tr> <tr> <td>MRS120W100</td> <td rowspan="2">150% torque 3%ED</td> <td>100</td> <td>0.75</td> </tr> <tr> <td>MRS120W60</td> <td>60</td> <td>1.5</td> </tr> <tr> <td>MRS120W40</td> <td>40</td> <td>2.2</td> </tr> <tr> <td rowspan="2" style="vertical-align: middle; font-weight: bold;">MYS type</td> <td rowspan="2">MYS220W50 *1</td> <td>150% torque 3%ED</td> <td rowspan="2">50/2</td> <td rowspan="2">2×80</td> <td>3.7</td> </tr> <tr> <td>100% torque 6%ED</td> <td>3.7</td> </tr> </tbody> </table>	Resistor Model		Control torque / permissible duty	Resistance Value (Ω)	Permissible Power (W)	Applicable Motor Capacity (kW)	200V	MRS type	MRS120W200	200	15	0.4	MRS120W100	150% torque 3%ED	100	0.75	MRS120W60	60	1.5	MRS120W40	40	2.2	MYS type	MYS220W50 *1	150% torque 3%ED	50/2	2×80	3.7	100% torque 6%ED	3.7
	Resistor Model		Control torque / permissible duty	Resistance Value (Ω)	Permissible Power (W)	Applicable Motor Capacity (kW)																									
200V	MRS type	MRS120W200	200	15	0.4																										
		MRS120W100	150% torque 3%ED	100	0.75																										
		MRS120W60		60	1.5																										
		MRS120W40	40	2.2																											
	MYS type	MYS220W50 *1	150% torque 3%ED	50/2	2×80	3.7																									
100% torque 6%ED			3.7																												
<p>*1 Two unit in parallel</p> <p>(a) The temperature of the brake resistor becomes 200oC or more depending on the operation frequency, care must be taken for installation and heat dissipation.</p> <p>(b) The brake resistor cannot be used with the 0.1K and 0.2K.</p> <p>(c) Do not remove a jumper across terminal P/+ and P1 except when connecting a DC reactor.</p>																															

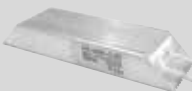
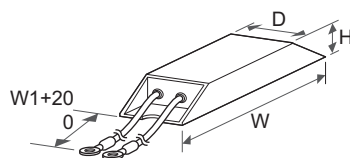
Name (model)	Specification and structure									
<p>High-duty brake resistor FR-ABR</p> 	• Outline dimension (Unit: mm)									
			200V							
	Brake Resistor Model	Permissible Brake Duty	Outline Dimension				Resistance Value (Ω)	Approx. Mass (kg)		
	FR-ABR-0.4K	10%	140	500	40	21	200	0.2		
	FR-ABR-0.75K	10%	215	500	40	21	100	0.4		
	FR-ABR-2.2K *1	10%	240	500	50	26	60	0.5		
		10%								
	FR-ABR-3.7K	10%	215	500	61	33	40	0.8		
	FR-ABR-5.5K	10%	335	500	61	33	25	1.3		
	FR-ABR-7.5K	10%	400	500	80	40	20	2.2		
	FR-ABR-11K	6%	400	700	100	50	13	3.5		
	FR-ABR-15K *2	6%	300	700	100	50	18(×1/2)	2.4(×2)		
			400V							
	Brake Resistor Model	Permissible Brake Duty	Outline Dimension				Resistance Value (Ω)	Approx. Mass (kg)		
	FR-ABR-H0.4K	10%	115	500	40	21	1200	0.2		
	FR-ABR-H0.75K	10%	140	500	40	21	700	0.2		
	FR-ABR-H1.5K	10%	215	500	40	21	350	0.4		
	FR-ABR-H2.2K	10%	240	500	50	26	250	0.5		
	FR-ABR-H3.7K	10%	215	500	61	33	150	0.8		
	FR-ABR-H5.5K	10%	335	500	61	33	110	1.3		
FR-ABR-H7.5K	10%	400	500	80	40	75	2.2			
FR-ABR-H11K	6%	400	700	100	50	52	3.2			
FR-ABR-H15K *3	6%	300	700	100	50	18(×2)	2.4(×2)			
										
		<p>*1 For the 1.5K and 2.2K inverter. *2 For the 15K brake resistor, configure so that two 18Ω resistors are connected in parallel. *3 For the 15K brake resistor, configure so that two 18Ω resistors are connected in series. FR-ABR-15K is indicated on the resistor. (same resistor as the 200V class 15K)</p> <p>(a) The regenerative brake duty setting should be less than permissible brake duty in the table above. (b) The temperature of the brake resistor becomes 300°C or more depending on the operation frequency, care must be taken for installation and heat dissipation. (c) MYS type resistor can be also used. Note that the permissible brake duty. (d) The brake resistor cannot be used with the 0.1K and 0.2K. (e) Do not remove a jumper across terminal P/+ and P1 exceptwhen connecting a DC reactor.</p>								

Name (model)	Specification and structure																																																																																																																																																																																																																											
	<p>Provides a braking capability greater than that is provided by an external brake resistor. This option can also be connected to the inverters without built-in brake transistors. Three types of discharging resistors are available. Make a selection according to the required braking torque.</p> <ul style="list-style-type: none"> Specification [Brake unit] <table border="1"> <thead> <tr> <th rowspan="2">7.5K 15K 30K-□</th> <th colspan="5">200V</th> <th colspan="3">400V</th> </tr> <tr> <th>1.5K</th> <th>3.7K</th> <th>7.5K</th> <th>15K</th> <th>30K</th> <th>H7.5K</th> <th>H15K</th> <th>H30K</th> </tr> </thead> <tbody> <tr> <td>Applicable motor capacity</td> <td colspan="8">The applicable capacity differs by the braking torque and the operation rate (%ED).</td> </tr> <tr> <td>Connected brake resistor</td> <td colspan="8">GRZG type, FR-BR, MT-BR5 (For the combination, refer to the table below.)</td> </tr> <tr> <td>Multiple (parallel) driving</td> <td colspan="8">Max. 10 units (However, the torque is limited by the permissible current of the connected inverter.)</td> </tr> <tr> <td>Approximate mass (kg)</td> <td>0.9</td> <td>0.9</td> <td>0.9</td> <td>0.9</td> <td>1.4</td> <td>0.9</td> <td>0.9</td> <td>1.4</td> </tr> </tbody> </table> <p>[Discharging resistor]</p> <table border="1"> <thead> <tr> <th rowspan="2">Model: GRZG type *1</th> <th colspan="4">200V</th> <th colspan="3">400V</th> </tr> <tr> <th>GZG300W-50Ω (1 unit)</th> <th>GRZG200-10Ω (3 units)</th> <th>GRZG300-5Ω (4 units)</th> <th>GRZG400-2Ω (6 units)</th> <th>GRZG200-10Ω (3 units)</th> <th>GRZG300-5Ω (4 units)</th> <th>GRZG400-2Ω (6 units)</th> </tr> </thead> <tbody> <tr> <td>Number of connectable units</td> <td>1 unit</td> <td>3 in series (1 set)</td> <td>4 in series (1 set)</td> <td>6 in series (1 set)</td> <td>6 in series (2 sets)</td> <td>8 in series (2 sets)</td> <td>12 in series (2 sets)</td> </tr> <tr> <td>Discharging resistor combined resistance (Ω)</td> <td>50</td> <td>30</td> <td>20</td> <td>12</td> <td>60</td> <td>40</td> <td>24</td> </tr> <tr> <td>Continuous operation permissible power (W)</td> <td>100</td> <td>300</td> <td>600</td> <td>1200</td> <td>600</td> <td>1200</td> <td>2400</td> </tr> </tbody> </table> <p>[Resistor unit]</p> <table border="1"> <thead> <tr> <th rowspan="2">Model: FR-BR-□</th> <th colspan="3">200 V</th> <th>400 V</th> </tr> <tr> <th>15K</th> <th>30K</th> <th>55K</th> <th>H15K</th> </tr> </thead> <tbody> <tr> <td>Discharging resistor combined resistance (Ω)</td> <td>8</td> <td>4</td> <td>2</td> <td>32</td> </tr> <tr> <td>Continuous operation permissible power (W)</td> <td>990</td> <td>1990</td> <td>3910</td> <td>990</td> </tr> <tr> <td>Approximate mass (kg)</td> <td>15</td> <td>30</td> <td>70</td> <td>15</td> </tr> </tbody> </table> <p>*1 The 1 set contains the number of units in the parentheses. For the 400 V class, 2 sets are required.</p> <ul style="list-style-type: none"> Combination between the brake unit and the resistor unit <table border="1"> <thead> <tr> <th rowspan="3">Brake unit model</th> <th colspan="3">Discharging resistor model or resistor unit model</th> </tr> <tr> <th colspan="2">GRZG type</th> <th rowspan="2">FR-BR</th> </tr> <tr> <th>Model *1</th> <th>Number of connectable units</th> </tr> </thead> <tbody> <tr> <td rowspan="5">200V</td> <td>FR-BU2-1.5K</td> <td>GZG 300W-50Ω (1 unit)</td> <td>1 unit</td> <td>-</td> </tr> <tr> <td>FR-BU2-3.7K</td> <td>GRZG 200-10Ω (3 units)</td> <td>3 in series (1 set)</td> <td>-</td> </tr> <tr> <td>FR-BU2-7.5K</td> <td>GRZG 300-5Ω (4 units)</td> <td>4 in series (1 set)</td> <td>-</td> </tr> <tr> <td>FR-BU2-15K</td> <td>GRZG 400-2Ω (6 units)</td> <td>6 in series (1 set)</td> <td>FR-BR-15K</td> </tr> <tr> <td>FR-BU2-30K</td> <td>-</td> <td>-</td> <td>FR-BR-30K</td> </tr> <tr> <td rowspan="3">400V</td> <td>FR-BU2-H7.5K</td> <td>GRZG 200-10Ω (3 units)</td> <td>6 in series (2 sets)</td> <td>-</td> </tr> <tr> <td>FR-BU2-H15K</td> <td>GRZG 300-5Ω (4 units)</td> <td>8 in series (2 sets)</td> <td>FR-BR-H15K</td> </tr> <tr> <td>FR-BU2-H30K</td> <td>GRZG 400-2Ω (6 units)</td> <td>12 in series (2 sets)</td> <td>FR-BR-H30K</td> </tr> </tbody> </table> <p>*1 The 1 set contains the number of units in the parentheses. For the 400 V class, 2 sets are required.</p> <ul style="list-style-type: none"> Selection method [GRZG type] <p>The maximum temperature rise of the discharging resistors is about 200°C. Use heat-resistant wires to perform wiring, and make sure that they will not come in contact with resistors. Do not touch the discharging resistor while the power is ON or for about 10 minutes after the power supply turns OFF. Otherwise you may get an electric shock</p> <table border="1"> <thead> <tr> <th rowspan="2">Power supply voltage</th> <th rowspan="2">Braking torque</th> <th colspan="8">Motor capacity (kW)</th> </tr> <tr> <th>0.4</th> <th>0.75</th> <th>1.5</th> <th>2.2</th> <th>3.7</th> <th>5.5</th> <th>7.5</th> <th>11</th> <th>15</th> </tr> </thead> <tbody> <tr> <td rowspan="2">200V</td> <td>50% 30s</td> <td colspan="3">FR-BU2-1.5K</td> <td>FR-BU2-3.7K</td> <td>FR-BU2-7.5K</td> <td colspan="4">FR-BU2-15K</td> </tr> <tr> <td>100% 30s</td> <td>FR-BU2-1.5K</td> <td>FR-BU2-3.7K</td> <td>FR-BU2-7.5K</td> <td>FR-BU2-15K</td> <td colspan="4">2×FR-BU2-15K *1</td> </tr> <tr> <td rowspan="2">400V</td> <td>50% 30s</td> <td colspan="3">-*2</td> <td colspan="2">FR-BU2-H7.5K</td> <td colspan="4">FR-BU2-H15K</td> </tr> <tr> <td>100% 30s</td> <td colspan="3">-*2</td> <td>FR-BU2-H7.5K</td> <td>FR-BU2-H15K</td> <td colspan="4">FR-BU2-H30K</td> </tr> </tbody> </table> <p>*1 The number next to the model name indicates the number of connectable units in parallel. *2 The inverter for 400V class 1.5K or lower cannot be used in combination with a brake unit. To use in combination with a brake unit, use the inverter of 2.2K or higher.</p>	7.5K 15K 30K-□	200V					400V			1.5K	3.7K	7.5K	15K	30K	H7.5K	H15K	H30K	Applicable motor capacity	The applicable capacity differs by the braking torque and the operation rate (%ED).								Connected brake resistor	GRZG type, FR-BR, MT-BR5 (For the combination, refer to the table below.)								Multiple (parallel) driving	Max. 10 units (However, the torque is limited by the permissible current of the connected inverter.)								Approximate mass (kg)	0.9	0.9	0.9	0.9	1.4	0.9	0.9	1.4	Model: GRZG type *1	200V				400V			GZG300W-50Ω (1 unit)	GRZG200-10Ω (3 units)	GRZG300-5Ω (4 units)	GRZG400-2Ω (6 units)	GRZG200-10Ω (3 units)	GRZG300-5Ω (4 units)	GRZG400-2Ω (6 units)	Number of connectable units	1 unit	3 in series (1 set)	4 in series (1 set)	6 in series (1 set)	6 in series (2 sets)	8 in series (2 sets)	12 in series (2 sets)	Discharging resistor combined resistance (Ω)	50	30	20	12	60	40	24	Continuous operation permissible power (W)	100	300	600	1200	600	1200	2400	Model: FR-BR-□	200 V			400 V	15K	30K	55K	H15K	Discharging resistor combined resistance (Ω)	8	4	2	32	Continuous operation permissible power (W)	990	1990	3910	990	Approximate mass (kg)	15	30	70	15	Brake unit model	Discharging resistor model or resistor unit model			GRZG type		FR-BR	Model *1	Number of connectable units	200V	FR-BU2-1.5K	GZG 300W-50Ω (1 unit)	1 unit	-	FR-BU2-3.7K	GRZG 200-10Ω (3 units)	3 in series (1 set)	-	FR-BU2-7.5K	GRZG 300-5Ω (4 units)	4 in series (1 set)	-	FR-BU2-15K	GRZG 400-2Ω (6 units)	6 in series (1 set)	FR-BR-15K	FR-BU2-30K	-	-	FR-BR-30K	400V	FR-BU2-H7.5K	GRZG 200-10Ω (3 units)	6 in series (2 sets)	-	FR-BU2-H15K	GRZG 300-5Ω (4 units)	8 in series (2 sets)	FR-BR-H15K	FR-BU2-H30K	GRZG 400-2Ω (6 units)	12 in series (2 sets)	FR-BR-H30K	Power supply voltage	Braking torque	Motor capacity (kW)								0.4	0.75	1.5	2.2	3.7	5.5	7.5	11	15	200V	50% 30s	FR-BU2-1.5K			FR-BU2-3.7K	FR-BU2-7.5K	FR-BU2-15K				100% 30s	FR-BU2-1.5K	FR-BU2-3.7K	FR-BU2-7.5K	FR-BU2-15K	2×FR-BU2-15K *1				400V	50% 30s	-*2			FR-BU2-H7.5K		FR-BU2-H15K				100% 30s	-*2			FR-BU2-H7.5K	FR-BU2-H15K	FR-BU2-H30K			
7.5K 15K 30K-□	200V					400V																																																																																																																																																																																																																						
	1.5K	3.7K	7.5K	15K	30K	H7.5K	H15K	H30K																																																																																																																																																																																																																				
Applicable motor capacity	The applicable capacity differs by the braking torque and the operation rate (%ED).																																																																																																																																																																																																																											
Connected brake resistor	GRZG type, FR-BR, MT-BR5 (For the combination, refer to the table below.)																																																																																																																																																																																																																											
Multiple (parallel) driving	Max. 10 units (However, the torque is limited by the permissible current of the connected inverter.)																																																																																																																																																																																																																											
Approximate mass (kg)	0.9	0.9	0.9	0.9	1.4	0.9	0.9	1.4																																																																																																																																																																																																																				
Model: GRZG type *1	200V				400V																																																																																																																																																																																																																							
	GZG300W-50Ω (1 unit)	GRZG200-10Ω (3 units)	GRZG300-5Ω (4 units)	GRZG400-2Ω (6 units)	GRZG200-10Ω (3 units)	GRZG300-5Ω (4 units)	GRZG400-2Ω (6 units)																																																																																																																																																																																																																					
Number of connectable units	1 unit	3 in series (1 set)	4 in series (1 set)	6 in series (1 set)	6 in series (2 sets)	8 in series (2 sets)	12 in series (2 sets)																																																																																																																																																																																																																					
Discharging resistor combined resistance (Ω)	50	30	20	12	60	40	24																																																																																																																																																																																																																					
Continuous operation permissible power (W)	100	300	600	1200	600	1200	2400																																																																																																																																																																																																																					
Model: FR-BR-□	200 V			400 V																																																																																																																																																																																																																								
	15K	30K	55K	H15K																																																																																																																																																																																																																								
Discharging resistor combined resistance (Ω)	8	4	2	32																																																																																																																																																																																																																								
Continuous operation permissible power (W)	990	1990	3910	990																																																																																																																																																																																																																								
Approximate mass (kg)	15	30	70	15																																																																																																																																																																																																																								
Brake unit model	Discharging resistor model or resistor unit model																																																																																																																																																																																																																											
	GRZG type		FR-BR																																																																																																																																																																																																																									
	Model *1	Number of connectable units																																																																																																																																																																																																																										
200V	FR-BU2-1.5K	GZG 300W-50Ω (1 unit)	1 unit	-																																																																																																																																																																																																																								
	FR-BU2-3.7K	GRZG 200-10Ω (3 units)	3 in series (1 set)	-																																																																																																																																																																																																																								
	FR-BU2-7.5K	GRZG 300-5Ω (4 units)	4 in series (1 set)	-																																																																																																																																																																																																																								
	FR-BU2-15K	GRZG 400-2Ω (6 units)	6 in series (1 set)	FR-BR-15K																																																																																																																																																																																																																								
	FR-BU2-30K	-	-	FR-BR-30K																																																																																																																																																																																																																								
400V	FR-BU2-H7.5K	GRZG 200-10Ω (3 units)	6 in series (2 sets)	-																																																																																																																																																																																																																								
	FR-BU2-H15K	GRZG 300-5Ω (4 units)	8 in series (2 sets)	FR-BR-H15K																																																																																																																																																																																																																								
	FR-BU2-H30K	GRZG 400-2Ω (6 units)	12 in series (2 sets)	FR-BR-H30K																																																																																																																																																																																																																								
Power supply voltage	Braking torque	Motor capacity (kW)																																																																																																																																																																																																																										
		0.4	0.75	1.5	2.2	3.7	5.5	7.5	11	15																																																																																																																																																																																																																		
200V	50% 30s	FR-BU2-1.5K			FR-BU2-3.7K	FR-BU2-7.5K	FR-BU2-15K																																																																																																																																																																																																																					
	100% 30s	FR-BU2-1.5K	FR-BU2-3.7K	FR-BU2-7.5K	FR-BU2-15K	2×FR-BU2-15K *1																																																																																																																																																																																																																						
400V	50% 30s	-*2			FR-BU2-H7.5K		FR-BU2-H15K																																																																																																																																																																																																																					
	100% 30s	-*2			FR-BU2-H7.5K	FR-BU2-H15K	FR-BU2-H30K																																																																																																																																																																																																																					

Brake unit
FR-BU2
Resistor unit
FR-BR
Discharging resistor
GZG type, GRZG type



Name (model)

Specification and structure

[FR-BR]

The maximum temperature rise of the resistor unit is about 100°C. Therefore, use heat-resistant wires (such as glass wires).

%ED at short-time rating when braking torque is 100%

Model	Motor capacity(kW)	%ED			
		5.5kW	7.5kW	11kW	15kW
200V	FR-BU2-15K	80	40	15	10
	FR-BU2-30K	-	-	65	30
400V	FR-BU2-H15K	80	40	15	10
	FR-BU2-H30K	-	-	65	30

Braking torque (%) at 10%ED in short-time rating of 15 s

Model	Motor capacity(kW)	Braking torque (%)			
		5.5kW	7.5kW	11kW	15kW
200V	FR-BU2-15K	280	200	120	100
	FR-BU2-30K	-	-	260	180
400V	FR-BU2-H15K	280	200	120	100
	FR-BU2-H30K	-	-	260	180

$$\text{Regeneration duty factor (operation frequency)\%ED} = \frac{t_b}{t_c} \times 100 \quad t_b < 15s \text{ (continuous operation time)}$$

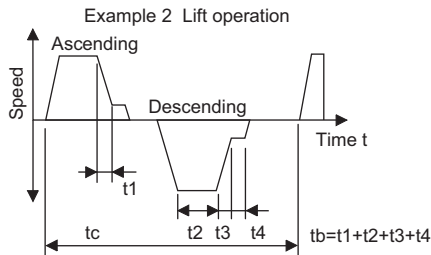
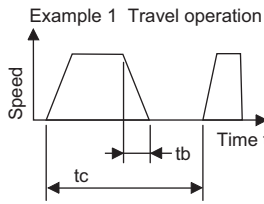

• Connection diagram

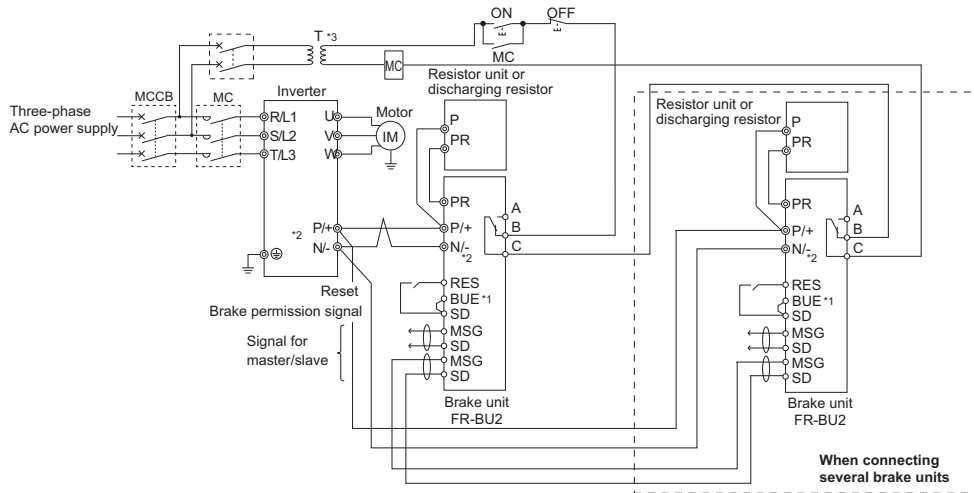

- *1 A jumper is connected across BUE and SD in the initial status.
- *2 Connect the inverter terminals (P/+, N/-) and brake unit (FR-BU2) terminals so that their terminal symbols match with each other. Incorrect connection will damage the inverter. Do not remove a jumper across terminal P/+ and P1 except when connecting a DC reactor.
- *3 When the power supply is 400V class, install a step-down transformer.

• Outline dimension (Unit: mm)

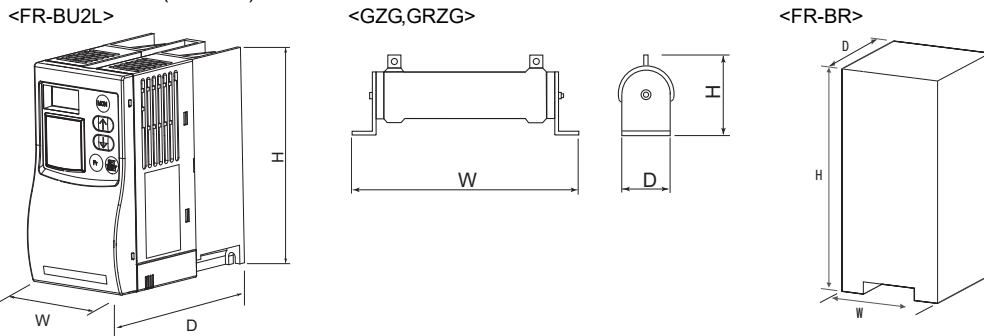

Model	W	H	D
FR-BU2-1.5K to 15K	68	128	132.5
FR-BU2-30K	108	128	129.5
FR-BU2-H7.5K, H15K	68	128	132.5
FR-BU2-H30K	108	128	129.5

Model	W	H	D
GZG300W	335	78	40
GRZG200	306	55	26
GRZG300	334	79	40
GRZG400	411	79	40

Model	W	H	D
FR-BR-15K	170	450	220
FR-BR-30K	340	600	220
FR-BR-H15K	170	450	220
FR-BR-H30K	340	600	220

Brake unit
FR-BU2
Resistor unit
FR-BR
Discharging resistor
GZG type, GRZG type



Name (model)	Specification and structure																																																																																																																																																																																																																
<p>Multifunction regeneration converter FR-XC</p> <p>Dedicated stand-alone reactor FR-XCL</p> <p>Dedicated box-type reactor FR-XCB</p> 	<p>One inverter can handle harmonic suppression and power regeneration. Functions that match the application can be selected by combining the inverter/converter with the dedicated reactor FR-XCB (boxtype) or FR-XCL.</p>																																																																																																																																																																																																																
	<p>• Combination</p>																																																																																																																																																																																																																
	<p><<Combination matrix of FR-XCL and FR-XC(-PWM)>></p>																																																																																																																																																																																																																
	<table border="1"> <thead> <tr> <th>Dedicated standalone reactor</th> <th colspan="2">Multifunction regeneration converter</th> </tr> <tr> <th>FR-XCL-[]</th> <th>FR-XC-[]</th> <th>FR-XC-[]-PWM *1</th> </tr> </thead> <tbody> <tr><td>7.5K</td><td>7.5K</td><td>-</td></tr> <tr><td>11K</td><td>11K</td><td>-</td></tr> <tr><td>15K</td><td>15K</td><td>-</td></tr> <tr><td>22K</td><td>22K</td><td>18.5K</td></tr> <tr><td>30K</td><td>30K</td><td>22K</td></tr> <tr><td>37K</td><td>37K</td><td>37K</td></tr> <tr><td>55K</td><td>55K</td><td>55K</td></tr> <tr><td>H7.5K</td><td>H7.5K</td><td>-</td></tr> <tr><td>H11K</td><td>H11K</td><td>-</td></tr> <tr><td>H15K</td><td>H15K</td><td>-</td></tr> <tr><td>H22K</td><td>H22K</td><td>H18.5K</td></tr> <tr><td>H30K</td><td>H30K</td><td>H22K</td></tr> <tr><td>H37K</td><td>H37K</td><td>H37K</td></tr> <tr><td>H55K</td><td>H55K</td><td>H55K</td></tr> </tbody> </table>													Dedicated standalone reactor	Multifunction regeneration converter		FR-XCL-[]	FR-XC-[]	FR-XC-[]-PWM *1	7.5K	7.5K	-	11K	11K	-	15K	15K	-	22K	22K	18.5K	30K	30K	22K	37K	37K	37K	55K	55K	55K	H7.5K	H7.5K	-	H11K	H11K	-	H15K	H15K	-	H22K	H22K	H18.5K	H30K	H30K	H22K	H37K	H37K	H37K	H55K	H55K	H55K																																																																																																																																																				
	Dedicated standalone reactor	Multifunction regeneration converter																																																																																																																																																																																																															
	FR-XCL-[]	FR-XC-[]	FR-XC-[]-PWM *1																																																																																																																																																																																																														
	7.5K	7.5K	-																																																																																																																																																																																																														
	11K	11K	-																																																																																																																																																																																																														
	15K	15K	-																																																																																																																																																																																																														
	22K	22K	18.5K																																																																																																																																																																																																														
30K	30K	22K																																																																																																																																																																																																															
37K	37K	37K																																																																																																																																																																																																															
55K	55K	55K																																																																																																																																																																																																															
H7.5K	H7.5K	-																																																																																																																																																																																																															
H11K	H11K	-																																																																																																																																																																																																															
H15K	H15K	-																																																																																																																																																																																																															
H22K	H22K	H18.5K																																																																																																																																																																																																															
H30K	H30K	H22K																																																																																																																																																																																																															
H37K	H37K	H37K																																																																																																																																																																																																															
H55K	H55K	H55K																																																																																																																																																																																																															
<p><<Combination matrix of FR-XCB and FR-XC(-PWM)>></p>																																																																																																																																																																																																																	
<table border="1"> <thead> <tr> <th>Dedicated box-type reactor</th> <th colspan="2">Multifunction regeneration converter</th> </tr> <tr> <th>FR-XCB-[]</th> <th>FR-XC-[] *2</th> <th>FR-XC-[]-PWM</th> </tr> </thead> <tbody> <tr><td>18.5K</td><td>22K</td><td>18.5K</td></tr> <tr><td>22K</td><td>30K</td><td>22K</td></tr> <tr><td>37K</td><td>37K</td><td>37K</td></tr> <tr><td>55K</td><td>55K</td><td>55K</td></tr> <tr><td>H18.5K</td><td>H22K</td><td>H18.5K</td></tr> <tr><td>H22K</td><td>H30K</td><td>H22K</td></tr> <tr><td>H37K</td><td>H37K</td><td>H37K</td></tr> <tr><td>H55K</td><td>H55K</td><td>H55K</td></tr> </tbody> </table>													Dedicated box-type reactor	Multifunction regeneration converter		FR-XCB-[]	FR-XC-[] *2	FR-XC-[]-PWM	18.5K	22K	18.5K	22K	30K	22K	37K	37K	37K	55K	55K	55K	H18.5K	H22K	H18.5K	H22K	H30K	H22K	H37K	H37K	H37K	H55K	H55K	H55K																																																																																																																																																																							
Dedicated box-type reactor	Multifunction regeneration converter																																																																																																																																																																																																																
FR-XCB-[]	FR-XC-[] *2	FR-XC-[]-PWM																																																																																																																																																																																																															
18.5K	22K	18.5K																																																																																																																																																																																																															
22K	30K	22K																																																																																																																																																																																																															
37K	37K	37K																																																																																																																																																																																																															
55K	55K	55K																																																																																																																																																																																																															
H18.5K	H22K	H18.5K																																																																																																																																																																																																															
H22K	H30K	H22K																																																																																																																																																																																																															
H37K	H37K	H37K																																																																																																																																																																																																															
H55K	H55K	H55K																																																																																																																																																																																																															
<p><<Combination matrix of FR-XCCP and FR-XC(-PWM)>></p>																																																																																																																																																																																																																	
<table border="1"> <thead> <tr> <th>Converter installation attachment for enclosure</th> <th>Multifunction regeneration converter</th> </tr> <tr> <th>FR-XCCP[]</th> <th>FR-XC-[]</th> </tr> </thead> <tbody> <tr><td>01</td><td>(H) 7.5K</td></tr> <tr><td></td><td>(H) 11K</td></tr> <tr><td>02</td><td>(H) 15K</td></tr> <tr><td rowspan="4">03</td><td>(H) 22K</td></tr> <tr><td>(H) 30K</td></tr> <tr><td>(H) 18.5K-PWM</td></tr> <tr><td>(H) 22K-PWM</td></tr> </tbody> </table>													Converter installation attachment for enclosure	Multifunction regeneration converter	FR-XCCP[]	FR-XC-[]	01	(H) 7.5K		(H) 11K	02	(H) 15K	03	(H) 22K	(H) 30K	(H) 18.5K-PWM	(H) 22K-PWM																																																																																																																																																																																						
Converter installation attachment for enclosure	Multifunction regeneration converter																																																																																																																																																																																																																
FR-XCCP[]	FR-XC-[]																																																																																																																																																																																																																
01	(H) 7.5K																																																																																																																																																																																																																
	(H) 11K																																																																																																																																																																																																																
02	(H) 15K																																																																																																																																																																																																																
03	(H) 22K																																																																																																																																																																																																																
	(H) 30K																																																																																																																																																																																																																
	(H) 18.5K-PWM																																																																																																																																																																																																																
	(H) 22K-PWM																																																																																																																																																																																																																
<p><<Combination matrix of FR-XCCU and FR-XC(-PWM)>></p>																																																																																																																																																																																																																	
<table border="1"> <thead> <tr> <th>IP20 compatible attachment</th> <th>Multifunction regeneration converter</th> </tr> <tr> <th>FR-XCCU[]</th> <th>FR-XC-[] (-PWM)</th> </tr> </thead> <tbody> <tr><td>01</td><td>37K</td></tr> <tr><td></td><td>H55K</td></tr> <tr><td>02</td><td>55K</td></tr> <tr><td>03</td><td>H37K</td></tr> </tbody> </table>													IP20 compatible attachment	Multifunction regeneration converter	FR-XCCU[]	FR-XC-[] (-PWM)	01	37K		H55K	02	55K	03	H37K																																																																																																																																																																																									
IP20 compatible attachment	Multifunction regeneration converter																																																																																																																																																																																																																
FR-XCCU[]	FR-XC-[] (-PWM)																																																																																																																																																																																																																
01	37K																																																																																																																																																																																																																
	H55K																																																																																																																																																																																																																
02	55K																																																																																																																																																																																																																
03	H37K																																																																																																																																																																																																																
<p>*1 The harmonic suppression function is preenabled in this model. To use the converter with the FR-XCL, change the "9999" setting of Pr.416 Control method selection to "0" (harmonic suppression disabled).</p>																																																																																																																																																																																																																	
<p>*2 The harmonic suppression function is not preenabled in this model. To use the converter with the FR-XCB, change the "9999" setting of Pr.416 Control method selection to "1" (harmonic suppression enabled).</p>																																																																																																																																																																																																																	
<p>• Specifications</p>																																																																																																																																																																																																																	
<p><<200V class>></p>																																																																																																																																																																																																																	
<table border="1"> <thead> <tr> <th colspan="2">Model *1</th> <th colspan="7">FR-XC-[]K</th> <th colspan="4">FR-XC-[]K-PWM</th> </tr> <tr> <th rowspan="2">Common bus regeneration mode</th> <th rowspan="2">Applicable inverter capacity (kW)</th> <th>Harmonic suppression</th> <th>7.5</th> <th>11</th> <th>15</th> <th>22</th> <th>30</th> <th>37</th> <th>55</th> <th>18.5</th> <th>22</th> <th>37</th> <th>55</th> </tr> </thead> <tbody> <tr> <td></td> <td></td> <td>Disabled</td> <td>7.5</td> <td>11</td> <td>15</td> <td>22</td> <td>30</td> <td>37</td> <td>55</td> <td>22</td> <td>30</td> <td>37</td> <td>55</td> </tr> <tr> <td></td> <td></td> <td>Enabled</td> <td>-</td> <td>-</td> <td>-</td> <td>18.5</td> <td>22</td> <td>37</td> <td>55</td> <td>18.5</td> <td>22</td> <td>37</td> <td>55</td> </tr> <tr> <td></td> <td>Overload current rating</td> <td></td> <td colspan="7">100% continuous /150% 60 s</td> <td colspan="4">100% continuous /150% 60 s</td> </tr> <tr> <td rowspan="2">Power regeneration mode *2</td> <td>Potential regenerative capacity (kW)</td> <td></td> <td>5.5</td> <td>7.5</td> <td>11</td> <td>18.5</td> <td>22</td> <td>30</td> <td>45</td> <td>18.5</td> <td>22</td> <td>30</td> <td>45</td> </tr> <tr> <td>Overload current rating</td> <td></td> <td colspan="7">100% continuous /150% 60 s</td> <td colspan="4">100% continuous /150% 60 s</td> </tr> <tr> <td rowspan="6">Power source</td> <td rowspan="2">Rated input AC voltage/frequency</td> <td>Disabled</td> <td colspan="7">Three-phase 200 to 240 V 50 Hz/60 Hz</td> <td colspan="4">Three-phase 200 to 240 V 50 Hz/60 Hz</td> </tr> <tr> <td>Enabled</td> <td>-</td> <td>-</td> <td>-</td> <td colspan="3">Three-phase 200 to 230 V 50 Hz/60 Hz *3</td> <td colspan="4">Three-phase 200 to 230 V 50 Hz/60 Hz *4</td> </tr> <tr> <td rowspan="2">Permissible AC voltage fluctuation</td> <td>Disabled</td> <td colspan="7">Three-phase 70 to 264 V 50 Hz/60 Hz</td> <td colspan="4">Three-phase 170 to 264 V 50 Hz/60 Hz</td> </tr> <tr> <td>Enabled</td> <td>-</td> <td>-</td> <td>-</td> <td colspan="3">Three-phase 170 to 253 V 50 Hz/60 Hz</td> <td colspan="4">Three-phase 170 to 253 V 50 Hz/60 Hz</td> </tr> <tr> <td rowspan="2">Permissible frequency fluctuation</td> <td>Disabled</td> <td colspan="7">±5%</td> <td colspan="4">±5%</td> </tr> <tr> <td>Enabled</td> <td>-</td> <td>-</td> <td>-</td> <td colspan="3">±5%</td> <td colspan="4">±5%</td> </tr> <tr> <td colspan="2">Input power factor</td> <td>Enabled</td> <td>-</td> <td>-</td> <td>-</td> <td colspan="4">0.99 or more (when load ratio is 100%)</td> <td colspan="4">0.99 or more (when load ratio is 100%)</td> </tr> <tr> <td colspan="3">Approx. mass (kg) *5</td> <td>5</td> <td>5</td> <td>6</td> <td>10.5</td> <td>10.5</td> <td>28</td> <td>38</td> <td>10.5</td> <td>10.5</td> <td>28</td> <td>38</td> </tr> </tbody> </table>													Model *1		FR-XC-[]K							FR-XC-[]K-PWM				Common bus regeneration mode	Applicable inverter capacity (kW)	Harmonic suppression	7.5	11	15	22	30	37	55	18.5	22	37	55			Disabled	7.5	11	15	22	30	37	55	22	30	37	55			Enabled	-	-	-	18.5	22	37	55	18.5	22	37	55		Overload current rating		100% continuous /150% 60 s							100% continuous /150% 60 s				Power regeneration mode *2	Potential regenerative capacity (kW)		5.5	7.5	11	18.5	22	30	45	18.5	22	30	45	Overload current rating		100% continuous /150% 60 s							100% continuous /150% 60 s				Power source	Rated input AC voltage/frequency	Disabled	Three-phase 200 to 240 V 50 Hz/60 Hz							Three-phase 200 to 240 V 50 Hz/60 Hz				Enabled	-	-	-	Three-phase 200 to 230 V 50 Hz/60 Hz *3			Three-phase 200 to 230 V 50 Hz/60 Hz *4				Permissible AC voltage fluctuation	Disabled	Three-phase 70 to 264 V 50 Hz/60 Hz							Three-phase 170 to 264 V 50 Hz/60 Hz				Enabled	-	-	-	Three-phase 170 to 253 V 50 Hz/60 Hz			Three-phase 170 to 253 V 50 Hz/60 Hz				Permissible frequency fluctuation	Disabled	±5%							±5%				Enabled	-	-	-	±5%			±5%				Input power factor		Enabled	-	-	-	0.99 or more (when load ratio is 100%)				0.99 or more (when load ratio is 100%)				Approx. mass (kg) *5			5	5	6	10.5	10.5	28	38	10.5	10.5	28	38
Model *1		FR-XC-[]K							FR-XC-[]K-PWM																																																																																																																																																																																																								
Common bus regeneration mode	Applicable inverter capacity (kW)	Harmonic suppression	7.5	11	15	22	30	37	55	18.5	22	37	55																																																																																																																																																																																																				
				Disabled	7.5	11	15	22	30	37	55	22	30	37	55																																																																																																																																																																																																		
		Enabled	-	-	-	18.5	22	37	55	18.5	22	37	55																																																																																																																																																																																																				
	Overload current rating		100% continuous /150% 60 s							100% continuous /150% 60 s																																																																																																																																																																																																							
Power regeneration mode *2	Potential regenerative capacity (kW)		5.5	7.5	11	18.5	22	30	45	18.5	22	30	45																																																																																																																																																																																																				
	Overload current rating		100% continuous /150% 60 s							100% continuous /150% 60 s																																																																																																																																																																																																							
Power source	Rated input AC voltage/frequency	Disabled	Three-phase 200 to 240 V 50 Hz/60 Hz							Three-phase 200 to 240 V 50 Hz/60 Hz																																																																																																																																																																																																							
		Enabled	-	-	-	Three-phase 200 to 230 V 50 Hz/60 Hz *3			Three-phase 200 to 230 V 50 Hz/60 Hz *4																																																																																																																																																																																																								
	Permissible AC voltage fluctuation	Disabled	Three-phase 70 to 264 V 50 Hz/60 Hz							Three-phase 170 to 264 V 50 Hz/60 Hz																																																																																																																																																																																																							
		Enabled	-	-	-	Three-phase 170 to 253 V 50 Hz/60 Hz			Three-phase 170 to 253 V 50 Hz/60 Hz																																																																																																																																																																																																								
	Permissible frequency fluctuation	Disabled	±5%							±5%																																																																																																																																																																																																							
		Enabled	-	-	-	±5%			±5%																																																																																																																																																																																																								
Input power factor		Enabled	-	-	-	0.99 or more (when load ratio is 100%)				0.99 or more (when load ratio is 100%)																																																																																																																																																																																																							
Approx. mass (kg) *5			5	5	6	10.5	10.5	28	38	10.5	10.5	28	38																																																																																																																																																																																																				

Multifunction regeneration converter
FR-XC
Dedicated stand-alone reactor
FR-XCL
Dedicated box-type reactor
FR-XCB



Name (model)		Specification and structure												
<<400V class>>														
		Model# 1		FR-XC-H[]K						FR-XC-H[]K-PWM				
		Harmonic suppression		7.5	11	15	22	30	37	55	18.5	22	37	55
Common bus regeneration mode	Applicable inverter capacity (kW)	Disabled		7.5	11	15	22	30	37	55	22	30	37	55
		Enabled		-	-	-	18.5	22	37	55	18.5	22	37	55
	Overload current rating	100% continuous /150% 60 s						100% continuous /150% 60 s						
Power regeneration mode *2	Potential regenerative capacity (kW)	Disabled		5.5	7.5	11	18.5	22	30	45	18.5	22	30	45
	Overload current rating	100% continuous /150% 60 s						100% continuous /150% 60s						
Power source	Rated input AC voltage/frequency	Disabled		Three-phase 380 to 500 V 50 Hz/60 Hz						Three-phase 380 to 500 V 50 Hz/60 Hz				
		Enabled		Three-phase 380 to 480 V 50 Hz/60 Hz *3						Three-phase 380 to 480 V 50 Hz/60 Hz *4				
	Permissible AC voltage fluctuation	Disabled		Three-phase 323 to 550 V 50 Hz/60 Hz						Three-phase 323 to 550 V 50 Hz/60 Hz				
		Enabled		Three-phase 323 to 506 V 50 Hz/60 Hz						Three-phase 323 to 506 V 50 Hz/60 Hz				
	Permissible frequency fluctuation	Disabled		±5%						±5%				
		Enabled		±5%						±5%				
Input power factor		Enabled		0.99 or more (when load ratio is 100%)						0.99 or more (when load ratio is 100%)				
Approx. mass (kg) *5				5	5	6	10.5	10.5	28	28	10.5	10.5	28	28

- *1 The harmonic suppression function is not pre-enabled in this model.
- *2 The power regeneration mode is selectable when the harmonic suppression function is disabled.
- *3 The DC bus voltage is approx. 297 VDC at an input voltage of 200 VAC, approx. 327 VDC at 220 VAC, and approx. 342 VDC at 230 VAC.
- *4 The DC bus voltage is approx. 594 VDC at an input voltage of 400 VAC, approx. 653 VDC at 440 VAC, and approx. 713 VDC at 480 VAC.
- *5 Mass of the FR-XC alone.

• Connection diagram
<<Common bus regeneration mode with harmonic suppression enabled>>

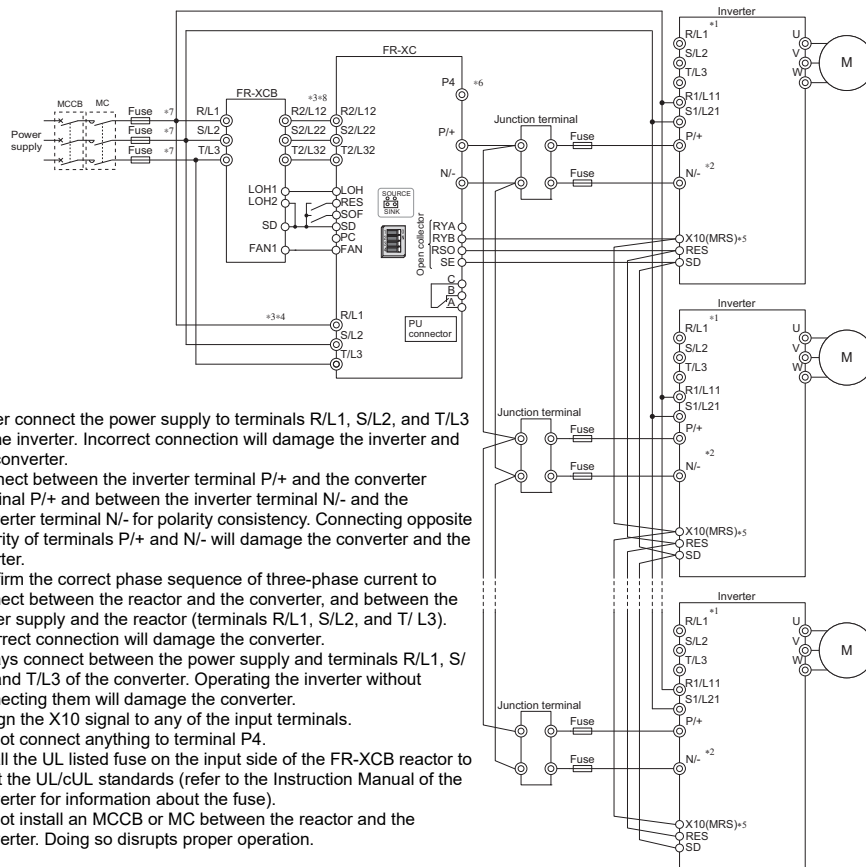

- *1 Never connect the power supply to terminals R/L1, S/L2, and T/L3 on the inverter. Incorrect connection will damage the inverter and the converter.
- *2 Connect between the inverter terminal P/+ and the converter terminal P/+ and between the inverter terminal N/- and the converter terminal N/- for polarity consistency. Connecting opposite polarity of terminals P/+ and N/- will damage the converter and the inverter.
- *3 Confirm the correct phase sequence of three-phase current to connect between the reactor and the converter, and between the power supply and the reactor (terminals R/L1, S/L2, and T/L3). Incorrect connection will damage the converter.
- *4 Always connect between the power supply and terminals R/L1, S/L2, and T/L3 of the converter. Operating the inverter without connecting them will damage the converter.
- *5 Assign the X10 signal to any of the input terminals.
- *6 Do not connect anything to terminal P4.
- *7 Install the UL listed fuse on the input side of the FR-XCB reactor to meet the UL/cUL standards (refer to the Instruction Manual of the converter for information about the fuse).
- *8 Do not install an MCCB or MC between the reactor and the converter. Doing so disrupts proper operation.

Name (model)

Multifunction regeneration converter FR-XC
Dedicated stand-alone reactor FR-XCL
Dedicated box-type reactor FR-XCB



Specification and structure

<<Power regeneration mode>>

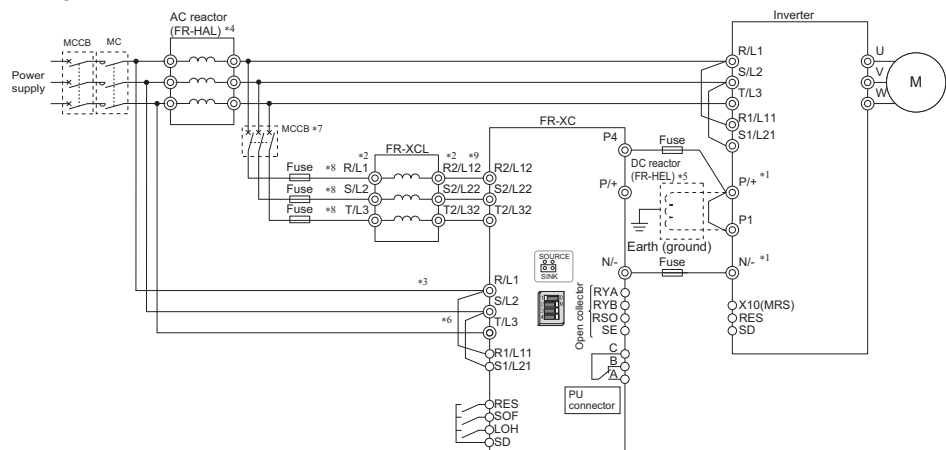

- *1 Connect between the inverter terminal P/+ and the converter terminal P4 and between the inverter terminal N/- and the converter terminal N/- for polarity consistency. Connecting the opposite polarity of terminals P/+ and N/- will damage the converter and the inverter.
- *2 Confirm the correct phase sequence of three-phase current to connect between the reactor and the converter, and between the power supply and the reactor. Incorrect connection will damage the converter.
- *3 Always connect between the power supply and terminals R/L1, S/L2, and T/L3 of the converter. Operating the inverter without connecting them will damage the converter. A branch point to each of these terminals must be placed between the power supply and the FR-HAL reactor.
- *4 Install the FR-HAL reactor between the node points joined to the converter terminals R/L1, S/L2, and T/L3 and the node points joined to the FR-XCL reactor. For further information, refer to the Instruction Manual.
- *5 To connect a DC reactor, remove a jumper installed across terminals P1 and P/+ before installing the DC reactor.
- *6 To use separate power supply for the control circuit, remove each jumper at terminal R1/L11 and terminal S1/L21.
- *7 Refer to the Instruction Manual to select an MCCB.
- *8 Install the UL listed fuse on the input side of the FR-XCL reactor to meet the UL/cUL standards (refer to the Instruction Manual of the reactor for information about the fuse).
- *9 Do not install an MCCB or MC between the reactor and the converter. Doing so disrupts proper operation.

• Outline dimension (Unit: mm)
 This is an example of the outer appearance, which differs depending on the model.

<<Multifunction regeneration converter FR-XC (-PWM)>>

•FR-XC-(H)7.5K, (H)11K, (H)15K •FR-XC-(H)22K, (H)30K
 •FR-XC-(H)18.5K-PWM, (H)22K-PWM

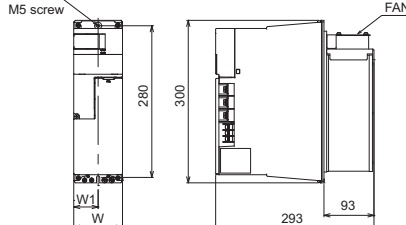
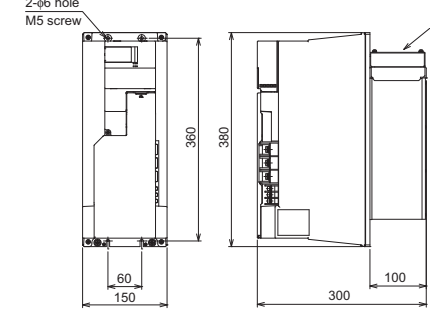

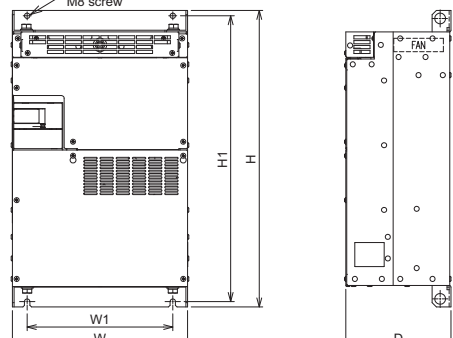

Model	W	W1
FR-XC-(H)7.5K, (H)11K	90	45
FR-XC-(H)15K	120	60

•FR-XC-(H)37K, (H)55K
 •FR-XC-(H)37K-PWM, (H)55K-PWM

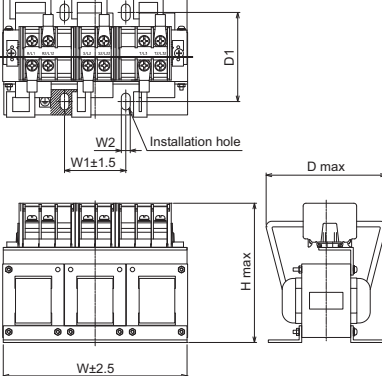
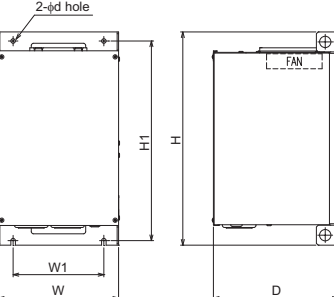
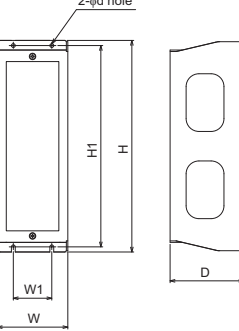

Model	W	W1	H	H1	D
FR-XC-(H)37K, H55K	325	270	550	530	195
FR-XC-(H)37K-PWM, H55K-PWM	325	270	550	530	195
FR-XC-55K	370	300	620	600	250
FR-XC-55K-PWM	370	300	620	600	250

Name (model)	Specification and structure																																																																										
<p>Multifunction regeneration converter FR-XC</p> <p>Dedicated stand-alone reactor FR-XCL</p> <p>Dedicated box-type reactor FR-XCB</p> 	<<Dedicated stand-alone reactor FR-XCL>>																																																																										
	200 V class																																																																										
	 <table border="1" data-bbox="758 280 1442 571"> <thead> <tr> <th>Model</th> <th>W</th> <th>W1</th> <th>W2</th> <th>H</th> <th>D</th> <th>D1</th> <th>Mounting screw size</th> <th>Terminal screw size</th> <th>Mass (kg)</th> </tr> </thead> <tbody> <tr> <td>FR-XCL-7.5K</td> <td rowspan="2">165</td> <td rowspan="2">55</td> <td rowspan="2">8</td> <td rowspan="2">125</td> <td>120</td> <td>80±2</td> <td rowspan="2">M6</td> <td rowspan="2">M5</td> <td>3.9</td> </tr> <tr> <td>FR-XCL-11K</td> <td>73±2</td> <td>3.6</td> </tr> <tr> <td>FR-XCL-15K</td> <td rowspan="2">192</td> <td rowspan="2">70</td> <td rowspan="2">10</td> <td rowspan="2">130</td> <td>130</td> <td>100±2</td> <td rowspan="2">M6</td> <td rowspan="2">M6</td> <td>5.5</td> </tr> <tr> <td>FR-XCL-22K</td> <td>140</td> <td>110±2</td> <td>6.3</td> </tr> <tr> <td>FR-XCL-30K</td> <td>240</td> <td>70</td> <td>10</td> <td>150</td> <td>160</td> <td>119±2</td> <td>M8</td> <td>M10</td> <td>10.0</td> </tr> <tr> <td>FR-XCL-37K</td> <td>248</td> <td>200</td> <td>10</td> <td>190</td> <td>240</td> <td>120±5</td> <td rowspan="2">M8</td> <td rowspan="2">M10</td> <td>12.0</td> </tr> <tr> <td>FR-XCL-55K</td> <td>250</td> <td>225</td> <td>10</td> <td>190</td> <td>260</td> <td>135±5</td> <td>15.5</td> </tr> </tbody> </table>										Model	W	W1	W2	H	D	D1	Mounting screw size	Terminal screw size	Mass (kg)	FR-XCL-7.5K	165	55	8	125	120	80±2	M6	M5	3.9	FR-XCL-11K	73±2	3.6	FR-XCL-15K	192	70	10	130	130	100±2	M6	M6	5.5	FR-XCL-22K	140	110±2	6.3	FR-XCL-30K	240	70	10	150	160	119±2	M8	M10	10.0	FR-XCL-37K	248	200	10	190	240	120±5	M8	M10	12.0	FR-XCL-55K	250	225	10	190	260	135±5	15.5
	Model	W	W1	W2	H	D	D1	Mounting screw size	Terminal screw size	Mass (kg)																																																																	
	FR-XCL-7.5K	165	55	8	125	120	80±2	M6	M5	3.9																																																																	
	FR-XCL-11K					73±2	3.6																																																																				
	FR-XCL-15K	192	70	10	130	130	100±2	M6	M6	5.5																																																																	
	FR-XCL-22K					140	110±2			6.3																																																																	
	FR-XCL-30K	240	70	10	150	160	119±2	M8	M10	10.0																																																																	
	FR-XCL-37K	248	200	10	190	240	120±5	M8	M10	12.0																																																																	
FR-XCL-55K	250	225	10	190	260	135±5	15.5																																																																				
400 V class																																																																											
<table border="1" data-bbox="758 600 1442 884"> <thead> <tr> <th>Model</th> <th>W</th> <th>W1</th> <th>W2</th> <th>H</th> <th>D</th> <th>D1</th> <th>Mounting screw size</th> <th>Terminal screw size</th> <th>Mass (kg)</th> </tr> </thead> <tbody> <tr> <td>FR-XCL-H7.5K</td> <td rowspan="3">165</td> <td rowspan="3">55</td> <td rowspan="3">8</td> <td rowspan="3">125</td> <td>120</td> <td>73±2</td> <td rowspan="3">M6</td> <td rowspan="3">M5</td> <td>3.7</td> </tr> <tr> <td>FR-XCL-H11K</td> <td>80±2</td> <td>4.2</td> </tr> <tr> <td>FR-XCL-H15K</td> <td>135</td> <td>110±2</td> <td>6.0</td> </tr> <tr> <td>FR-XCL-H22K</td> <td rowspan="2">240</td> <td rowspan="2">70</td> <td rowspan="2">10</td> <td rowspan="2">150</td> <td>150</td> <td>109±2</td> <td rowspan="2">M6</td> <td rowspan="2">M6</td> <td>9.0</td> </tr> <tr> <td>FR-XCL-H30K</td> <td>170</td> <td>129±2</td> <td>12.0</td> </tr> <tr> <td>FR-XCL-H37K</td> <td>220</td> <td>200</td> <td>10</td> <td>190</td> <td>230</td> <td>120±5</td> <td rowspan="2">M8</td> <td rowspan="2">M8</td> <td>12.0</td> </tr> <tr> <td>FR-XCL-H55K</td> <td>250</td> <td>225</td> <td>10</td> <td>190</td> <td>230</td> <td>135±5</td> <td>16.0</td> </tr> </tbody> </table>										Model	W	W1	W2	H	D	D1	Mounting screw size	Terminal screw size	Mass (kg)	FR-XCL-H7.5K	165	55	8	125	120	73±2	M6	M5	3.7	FR-XCL-H11K	80±2	4.2	FR-XCL-H15K	135	110±2	6.0	FR-XCL-H22K	240	70	10	150	150	109±2	M6	M6	9.0	FR-XCL-H30K	170	129±2	12.0	FR-XCL-H37K	220	200	10	190	230	120±5	M8	M8	12.0	FR-XCL-H55K	250	225	10	190	230	135±5	16.0							
Model	W	W1	W2	H	D	D1	Mounting screw size	Terminal screw size	Mass (kg)																																																																		
FR-XCL-H7.5K	165	55	8	125	120	73±2	M6	M5	3.7																																																																		
FR-XCL-H11K					80±2	4.2																																																																					
FR-XCL-H15K					135	110±2			6.0																																																																		
FR-XCL-H22K	240	70	10	150	150	109±2	M6	M6	9.0																																																																		
FR-XCL-H30K					170	129±2			12.0																																																																		
FR-XCL-H37K	220	200	10	190	230	120±5	M8	M8	12.0																																																																		
FR-XCL-H55K	250	225	10	190	230	135±5			16.0																																																																		
<<Dedicated box-type reactor FR-XCB>>																																																																											
200 V class(
 <table border="1" data-bbox="758 969 1380 1131"> <thead> <tr> <th>Model</th> <th>W</th> <th>W1</th> <th>H</th> <th>H1</th> <th>D</th> <th>d</th> <th>Screw size</th> <th>Mass (kg)</th> </tr> </thead> <tbody> <tr> <td>FR-XCB-18.5K</td> <td rowspan="2">265</td> <td rowspan="2">200</td> <td rowspan="2">470</td> <td rowspan="2">440</td> <td rowspan="2">275</td> <td rowspan="2">10</td> <td rowspan="2">M8</td> <td>26.0</td> </tr> <tr> <td>FR-XCB-22K</td> <td>56.9</td> </tr> <tr> <td>FR-XCB-37K</td> <td rowspan="2">350</td> <td rowspan="2">270</td> <td rowspan="2">600</td> <td rowspan="2">575</td> <td rowspan="2">330</td> <td rowspan="2">12</td> <td rowspan="2">M10</td> <td>68.5</td> </tr> <tr> <td>FR-XCB-55K</td> <td>73.0</td> </tr> </tbody> </table>										Model	W	W1	H	H1	D	d	Screw size	Mass (kg)	FR-XCB-18.5K	265	200	470	440	275	10	M8	26.0	FR-XCB-22K	56.9	FR-XCB-37K	350	270	600	575	330	12	M10	68.5	FR-XCB-55K	73.0																																			
Model	W	W1	H	H1	D	d	Screw size	Mass (kg)																																																																			
FR-XCB-18.5K	265	200	470	440	275	10	M8	26.0																																																																			
FR-XCB-22K								56.9																																																																			
FR-XCB-37K	350	270	600	575	330	12	M10	68.5																																																																			
FR-XCB-55K								73.0																																																																			
400 V class																																																																											
<table border="1" data-bbox="758 1182 1380 1344"> <thead> <tr> <th>Model</th> <th>W</th> <th>W1</th> <th>H</th> <th>H1</th> <th>D</th> <th>d</th> <th>Screw size</th> <th>Mass (kg)</th> </tr> </thead> <tbody> <tr> <td>FR-XCB-H18.5K</td> <td rowspan="2">265</td> <td rowspan="2">200</td> <td rowspan="2">470</td> <td rowspan="2">440</td> <td rowspan="2">275</td> <td rowspan="2">10</td> <td rowspan="2">M8</td> <td>26.9</td> </tr> <tr> <td>FR-XCB-H22K</td> <td>63.0</td> </tr> <tr> <td>FR-XCB-H37K</td> <td rowspan="2">350</td> <td rowspan="2">270</td> <td rowspan="2">600</td> <td rowspan="2">575</td> <td rowspan="2">330</td> <td rowspan="2">12</td> <td rowspan="2">M10</td> <td>73.0</td> </tr> <tr> <td>FR-XCB-H55K</td> <td>73.0</td> </tr> </tbody> </table>										Model	W	W1	H	H1	D	d	Screw size	Mass (kg)	FR-XCB-H18.5K	265	200	470	440	275	10	M8	26.9	FR-XCB-H22K	63.0	FR-XCB-H37K	350	270	600	575	330	12	M10	73.0	FR-XCB-H55K	73.0																																			
Model	W	W1	H	H1	D	d	Screw size	Mass (kg)																																																																			
FR-XCB-H18.5K	265	200	470	440	275	10	M8	26.9																																																																			
FR-XCB-H22K								63.0																																																																			
FR-XCB-H37K	350	270	600	575	330	12	M10	73.0																																																																			
FR-XCB-H55K								73.0																																																																			
<<Converter installation enclosure attachment FR-XCCP>>																																																																											
 <table border="1" data-bbox="774 1646 1300 1780"> <thead> <tr> <th>Model</th> <th>W</th> <th>W1</th> <th>H</th> <th>H1</th> <th>D</th> <th>d</th> <th>Screw size</th> </tr> </thead> <tbody> <tr> <td>FR-XCCP01</td> <td>110</td> <td>60</td> <td>330</td> <td>314</td> <td>115</td> <td>6</td> <td>M5</td> </tr> <tr> <td>FR-XCCP02</td> <td>130</td> <td>90</td> <td>330</td> <td>314</td> <td>120</td> <td>6</td> <td>M5</td> </tr> <tr> <td>FR-XCCP03</td> <td>160</td> <td>120</td> <td>410</td> <td>396</td> <td>116</td> <td>7</td> <td>M6</td> </tr> </tbody> </table>										Model	W	W1	H	H1	D	d	Screw size	FR-XCCP01	110	60	330	314	115	6	M5	FR-XCCP02	130	90	330	314	120	6	M5	FR-XCCP03	160	120	410	396	116	7	M6																																		
Model	W	W1	H	H1	D	d	Screw size																																																																				
FR-XCCP01	110	60	330	314	115	6	M5																																																																				
FR-XCCP02	130	90	330	314	120	6	M5																																																																				
FR-XCCP03	160	120	410	396	116	7	M6																																																																				

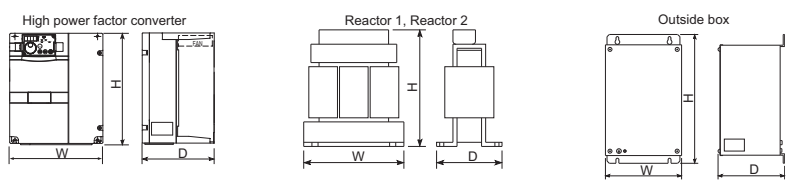
Name (model)	Specification and structure															
<p>High power factor converter FR-HC2-</p> 	Substantially suppresses power harmonics to obtain the equivalent capacity conversion coefficient K5 = 0 specified in "the Harmonic Suppression Guidelines for Consumers Who Receive High Voltage or Special High Voltage" in Japan.															
	The power regeneration function comes standard.															
	The common converter driving with several inverters is possible.															
	• Selection method															
	Select the model according to capacity of the inverter or the applicable motor, whichever larger.															
• Specifications																
Model: FR-HC2-□ *2	200 V					400 V										
Applicable inverter capacity (ND rating) *1	7.5K to 7.5K	15K to 15K	30K to 30K	55K to 55K	75K to 75K	H7.5K to 7.5K	H15K to 15K	H30K to 30K	H55K to 55K	H75K to 75K	H110K to 110K	H160K to 160K	H220K to 220K	H280K to 280K	H400K to 400K H560K to 560K	
Rated input voltage/frequency	Three-phase 200 V to 220 V 50 Hz 200 V to 230 V 60 Hz					Three-phase 380 V to 460 V 50/60 Hz										
Rated input current (A)	33	61	115	215	278	17	31	57	110	139	203	290	397	506	716 993	
*1 The total capacity of the connected inverters.																
*2 If a high power factor converter (FR-HC2) is purchased, it comes with reactor 1 (FR-HCL21), reactor 2 (FR-HCL22), and an outside box (FR-HCB2). Do not connect the DC reactor to the inverter when using a high power factor converter. (If an H280K or higher is purchased, it comes with FR-HCL21, FR-HCL22, FR-HCC2, FR-HCR2, and FR-HCM2.)																
• Outline dimension (Unit: mm)																
Voltage	Capacity	High power factor converter FR-HC2			Reactor 1 FR-HCL21 *1			Reactor 2 FR-HCL22 *1			Outside box FR-HCB2 *2					
		W	H	D	W	H	D	W	H	D	W	H	D			
200 V	7.5K	220	260	170	132	150	100	237.5	230	140	190	320	165			
	15K	250	400	190	162	172	126	257.5	260	165						
	30K	325	550	195	195	210	150	342.5	305	180	270	450	203			
	55K	370	620	250	210	180	200.5	432.5	380	280						
	75K	465	620	300	240	215	215.5	474	460	280				400	450	250
400 V	H7.5K	220	300	190	132	140	100	237.5	220	140	190	320	165			
	H15K	220	300	190	162	170	126	257.5	260	165						
	H30K	325	550	195	182	195	101	342.5	300	180	270	450	203			
	H55K	370	670	250	282.5	245	165	392.5	365	200				270	450	203
	H75K	325	620	250	210	175	210.5	430	395	280				300	350	250
	H110K	465	620	300	240	230	220	500	440	370	350	450	380			
	H160K	498	1010	380	280	295	274.5	560	520	430	400	450	440			
	H220K	498	1010	380	330	335	289.5	620	620	480						
	H280K	680	1010	380	330	335	321	690	700	560	-	-	-			
	H400K	790	1330	440	402	460	550	632	675	705	-	-	-			
H560K	790	1330	440	452	545	645	632	720	745	-	-	-				
																
*1 Install reactors (FR-HCL21 and 22) on a horizontal surface.																
*2 The H280K or higher are not equipped with FR-HCB2. A filter capacitor and inrush current limit resistors are provided instead.																

Name (model)	Specification and structure																																																																																																																				
Surge voltage suppression filter FR-ASF	A surge voltage suppression filter limits surge voltage applied to motor terminals when driving the 400 V class motor by the inverter.																																																																																																																				
	• Selection method Select the model according to the applied motor capacity.																																																																																																																				
	• Specifications																																																																																																																				
	<table border="1"> <thead> <tr> <th rowspan="2">Model: FR-ASF-□</th> <th colspan="7">400 V</th> </tr> <tr> <th>H1.5K</th> <th>H3.7K</th> <th>H7.5K</th> <th>H15K</th> <th>H22K</th> <th>H37K</th> <th>H55K</th> </tr> </thead> <tbody> <tr> <td>Applicable motor capacity (kW)</td> <td>0.4 to 1.5</td> <td>2.2 to 3.7</td> <td>5.5 to 7.5</td> <td>11 to 15</td> <td>18.5 to 22</td> <td>30 to 37</td> <td>45 to 55</td> </tr> <tr> <td>Rated input current (A)</td> <td>4.0</td> <td>9.0</td> <td></td> <td>31.0</td> <td>43.0</td> <td>71.0</td> <td>110.0</td> </tr> <tr> <td>Overload current rating *1</td> <td colspan="7">150% 60 s, 200% 0.5 s</td> </tr> <tr> <td>Rated input AC voltage *1</td> <td colspan="7">Three-phase 380 V to 460 V 50 Hz/60 Hz</td> </tr> <tr> <td>Maximum AC voltage fluctuation *1</td> <td colspan="7">Three-phase 506 V 50 Hz/60 Hz</td> </tr> <tr> <td>Maximum frequency *1</td> <td colspan="7">400 Hz</td> </tr> <tr> <td>PWM frequency permissible range</td> <td colspan="7">0.5 kHz to 14.5 kHz</td> </tr> <tr> <td>Maximum wiring length between the filter-motor</td> <td colspan="7">300 m</td> </tr> <tr> <td>Approx. mass (kg)</td> <td>8.0</td> <td>11.0</td> <td>20.0</td> <td>28.0</td> <td>38.0</td> <td>59.0</td> <td>78.0</td> </tr> <tr> <td rowspan="4">Environment</td> <td>Surrounding air temperature</td> <td colspan="6">-10°C to +50°C (non-freezing)</td> </tr> <tr> <td>Surrounding air humidity</td> <td colspan="6">90% RH or less (non-condensing)</td> </tr> <tr> <td>Atmosphere</td> <td colspan="6">Indoors (without corrosive gas, flammable gas, oil mist, dust and dirt, etc.)</td> </tr> <tr> <td>Altitude/vibration</td> <td colspan="6">Maximum 1000 m, 5.9 m/s² or less at 10 to 55 Hz (directions of X, Y, Z axes)</td> </tr> </tbody> </table>	Model: FR-ASF-□	400 V							H1.5K	H3.7K	H7.5K	H15K	H22K	H37K	H55K	Applicable motor capacity (kW)	0.4 to 1.5	2.2 to 3.7	5.5 to 7.5	11 to 15	18.5 to 22	30 to 37	45 to 55	Rated input current (A)	4.0	9.0		31.0	43.0	71.0	110.0	Overload current rating *1	150% 60 s, 200% 0.5 s							Rated input AC voltage *1	Three-phase 380 V to 460 V 50 Hz/60 Hz							Maximum AC voltage fluctuation *1	Three-phase 506 V 50 Hz/60 Hz							Maximum frequency *1	400 Hz							PWM frequency permissible range	0.5 kHz to 14.5 kHz							Maximum wiring length between the filter-motor	300 m							Approx. mass (kg)	8.0	11.0	20.0	28.0	38.0	59.0	78.0	Environment	Surrounding air temperature	-10°C to +50°C (non-freezing)						Surrounding air humidity	90% RH or less (non-condensing)						Atmosphere	Indoors (without corrosive gas, flammable gas, oil mist, dust and dirt, etc.)						Altitude/vibration	Maximum 1000 m, 5.9 m/s ² or less at 10 to 55 Hz (directions of X, Y, Z axes)					
	Model: FR-ASF-□		400 V																																																																																																																		
		H1.5K	H3.7K	H7.5K	H15K	H22K	H37K	H55K																																																																																																													
	Applicable motor capacity (kW)	0.4 to 1.5	2.2 to 3.7	5.5 to 7.5	11 to 15	18.5 to 22	30 to 37	45 to 55																																																																																																													
	Rated input current (A)	4.0	9.0		31.0	43.0	71.0	110.0																																																																																																													
	Overload current rating *1	150% 60 s, 200% 0.5 s																																																																																																																			
	Rated input AC voltage *1	Three-phase 380 V to 460 V 50 Hz/60 Hz																																																																																																																			
	Maximum AC voltage fluctuation *1	Three-phase 506 V 50 Hz/60 Hz																																																																																																																			
	Maximum frequency *1	400 Hz																																																																																																																			
	PWM frequency permissible range	0.5 kHz to 14.5 kHz																																																																																																																			
	Maximum wiring length between the filter-motor	300 m																																																																																																																			
	Approx. mass (kg)	8.0	11.0	20.0	28.0	38.0	59.0	78.0																																																																																																													
Environment	Surrounding air temperature	-10°C to +50°C (non-freezing)																																																																																																																			
	Surrounding air humidity	90% RH or less (non-condensing)																																																																																																																			
	Atmosphere	Indoors (without corrosive gas, flammable gas, oil mist, dust and dirt, etc.)																																																																																																																			
	Altitude/vibration	Maximum 1000 m, 5.9 m/s ² or less at 10 to 55 Hz (directions of X, Y, Z axes)																																																																																																																			
*1 Determined by the specification of the connected inverter (400 V class).																																																																																																																					
• Connection diagram																																																																																																																					
• Outline dimension (Unit: mm)																																																																																																																					
<table border="1"> <thead> <tr> <th>Model</th> <th>W *1</th> <th>H *1</th> <th>D *1</th> </tr> </thead> <tbody> <tr> <td>FR-ASF-H1.5K</td> <td>221</td> <td>193</td> <td>160</td> </tr> <tr> <td>FR-ASF-H3.7K</td> <td>221</td> <td>200</td> <td>180</td> </tr> <tr> <td>FR-ASF-H7.5K</td> <td>281</td> <td>250</td> <td>215</td> </tr> <tr> <td>FR-ASF-H15K *2</td> <td>336</td> <td>265</td> <td>290</td> </tr> <tr> <td>FR-ASF-H22K *2</td> <td>336</td> <td>345</td> <td>354</td> </tr> <tr> <td>FR-ASF-H37K *2</td> <td>376</td> <td>464</td> <td>429</td> </tr> <tr> <td>FR-ASF-H55K *2</td> <td>396</td> <td>464</td> <td>594</td> </tr> </tbody> </table>	Model	W *1	H *1	D *1	FR-ASF-H1.5K	221	193	160	FR-ASF-H3.7K	221	200	180	FR-ASF-H7.5K	281	250	215	FR-ASF-H15K *2	336	265	290	FR-ASF-H22K *2	336	345	354	FR-ASF-H37K *2	376	464	429	FR-ASF-H55K *2	396	464	594																																																																																					
Model	W *1	H *1	D *1																																																																																																																		
FR-ASF-H1.5K	221	193	160																																																																																																																		
FR-ASF-H3.7K	221	200	180																																																																																																																		
FR-ASF-H7.5K	281	250	215																																																																																																																		
FR-ASF-H15K *2	336	265	290																																																																																																																		
FR-ASF-H22K *2	336	345	354																																																																																																																		
FR-ASF-H37K *2	376	464	429																																																																																																																		
FR-ASF-H55K *2	396	464	594																																																																																																																		
*1 This indicates the maximum dimension.																																																																																																																					
*2 The H15K or higher has a different shape.																																																																																																																					

Name (model)	Specification and structure																																																																																																																			
<p style="text-align: center;">Surge voltage suppression filter FR-BMF</p>	Limits surge voltage applied to motor terminals when driving a 400 V class motor with an inverter.																																																																																																																			
	This filter is compatible with the 5.5 to 37 kW motors.																																																																																																																			
	• Selection method																																																																																																																			
	Select the model according to the applied motor capacity.																																																																																																																			
	• Specifications																																																																																																																			
	<table border="1" style="width: 100%; border-collapse: collapse;"> <thead> <tr> <th style="width: 15%;">Model: FR-BMF-H□K</th> <th colspan="2" style="width: 15%;">7.5</th> <th colspan="2" style="width: 15%;">15</th> <th colspan="2" style="width: 15%;">22</th> <th colspan="2" style="width: 15%;">37</th> </tr> </thead> <tbody> <tr> <td>Applicable motor capacity (kW) *1</td> <td>5.5</td> <td>7.5</td> <td>11</td> <td>15</td> <td>18.5</td> <td>22</td> <td>30</td> <td>37</td> </tr> <tr> <td>Rated current (A)</td> <td colspan="2">17</td> <td colspan="2">31</td> <td colspan="2">43</td> <td colspan="2">71</td> </tr> <tr> <td>Overload current rating *2</td> <td colspan="8">150% 60 s, 200% 0.5 s (inverse-time characteristics)</td> </tr> <tr> <td>Rated AC input voltage *2</td> <td colspan="8">Three-phase 380 to 480 V</td> </tr> <tr> <td>Permissible AC voltage fluctuation *2</td> <td colspan="8">323 to 528 V</td> </tr> <tr> <td>Maximum frequency *2</td> <td colspan="8">120 Hz</td> </tr> <tr> <td>PWM carrier frequency</td> <td colspan="8">2 kHz or lower *3</td> </tr> <tr> <td>Protective structure (JEM 1030)</td> <td colspan="8">Open type (IP00)</td> </tr> <tr> <td>Cooling system</td> <td colspan="8">Self-cooling</td> </tr> <tr> <td>Maximum wiring length</td> <td colspan="8">100m or lower</td> </tr> <tr> <td>Approx. mass (kg)</td> <td colspan="2">5.5</td> <td colspan="2">9.5</td> <td colspan="2">11.5</td> <td colspan="2">19</td> </tr> </tbody> </table>								Model: FR-BMF-H□K	7.5		15		22		37		Applicable motor capacity (kW) *1	5.5	7.5	11	15	18.5	22	30	37	Rated current (A)	17		31		43		71		Overload current rating *2	150% 60 s, 200% 0.5 s (inverse-time characteristics)								Rated AC input voltage *2	Three-phase 380 to 480 V								Permissible AC voltage fluctuation *2	323 to 528 V								Maximum frequency *2	120 Hz								PWM carrier frequency	2 kHz or lower *3								Protective structure (JEM 1030)	Open type (IP00)								Cooling system	Self-cooling								Maximum wiring length	100m or lower								Approx. mass (kg)	5.5		9.5		11.5		19	
	Model: FR-BMF-H□K	7.5		15		22		37																																																																																																												
	Applicable motor capacity (kW) *1	5.5	7.5	11	15	18.5	22	30	37																																																																																																											
	Rated current (A)	17		31		43		71																																																																																																												
	Overload current rating *2	150% 60 s, 200% 0.5 s (inverse-time characteristics)																																																																																																																		
	Rated AC input voltage *2	Three-phase 380 to 480 V																																																																																																																		
	Permissible AC voltage fluctuation *2	323 to 528 V																																																																																																																		
	Maximum frequency *2	120 Hz																																																																																																																		
	PWM carrier frequency	2 kHz or lower *3																																																																																																																		
	Protective structure (JEM 1030)	Open type (IP00)																																																																																																																		
Cooling system	Self-cooling																																																																																																																			
Maximum wiring length	100m or lower																																																																																																																			
Approx. mass (kg)	5.5		9.5		11.5		19																																																																																																													
<table border="1" style="width: 100%; border-collapse: collapse;"> <thead> <tr> <th style="width: 5%;">Environment</th> <th style="width: 25%;">Surrounding air temperature</th> <th colspan="6">-10°C to +50°C (non-freezing)</th> </tr> </thead> <tbody> <tr> <td></td> <td>Surrounding air humidity</td> <td colspan="6">90% RH or less (non-condensing)</td> </tr> <tr> <td></td> <td>Atmosphere</td> <td colspan="6">Indoors (without corrosive gas, flammable gas, oil mist, dust and dirt, etc.)</td> </tr> <tr> <td></td> <td>Altitude/vibration</td> <td colspan="6">Maximum 1000 m, 5.9 m/s² or less *4 at 10 to 55 Hz (directions of X, Y, Z axes)</td> </tr> </tbody> </table>								Environment	Surrounding air temperature	-10°C to +50°C (non-freezing)							Surrounding air humidity	90% RH or less (non-condensing)							Atmosphere	Indoors (without corrosive gas, flammable gas, oil mist, dust and dirt, etc.)							Altitude/vibration	Maximum 1000 m, 5.9 m/s ² or less *4 at 10 to 55 Hz (directions of X, Y, Z axes)																																																																																		
Environment	Surrounding air temperature	-10°C to +50°C (non-freezing)																																																																																																																		
	Surrounding air humidity	90% RH or less (non-condensing)																																																																																																																		
	Atmosphere	Indoors (without corrosive gas, flammable gas, oil mist, dust and dirt, etc.)																																																																																																																		
	Altitude/vibration	Maximum 1000 m, 5.9 m/s ² or less *4 at 10 to 55 Hz (directions of X, Y, Z axes)																																																																																																																		
*1 Indicates the maximum capacity applicable with the Mitsubishi Electric 4-pole standard motor. (PM motors are not applicable.)																																																																																																																				
*2 Determined by the specification of the connected inverter (400 V class).																																																																																																																				
*3 Set the Pr.72 PWM frequency selection to 2 kHz or less.																																																																																																																				
*4 When an inverter has a filter mounted on its back, do not use such an inverter on a moving object or in a place that vibrates (exceeding 1.96 m/s ²).																																																																																																																				
• Connection diagram																																																																																																																				
<p style="text-align: center;">* Install a step-down transformer.</p>																																																																																																																				
• Outline dimension (Unit: mm)																																																																																																																				
<table style="width: 100%; border: none;"> <tr> <td style="width: 33%; text-align: center;">FR-BMF-H7.5K</td> <td style="width: 33%; text-align: center;">FR-BMF-H15K, H22K</td> <td style="width: 33%; text-align: center;">FR-BMF-H37K</td> </tr> </table>								FR-BMF-H7.5K	FR-BMF-H15K, H22K	FR-BMF-H37K																																																																																																										
FR-BMF-H7.5K	FR-BMF-H15K, H22K	FR-BMF-H37K																																																																																																																		
<p style="text-align: center;">(Unit: mm)</p>																																																																																																																				

Low-Voltage Switchgear/Cables

● Mitsubishi Electric Molded Case Circuit Breakers and Earth Leakage Circuit Breakers WS-V Series

Our main series of products in the industry's smallest class with high breaking capability enabled by a new breaking technology.

The new WS-V series breaker has enhanced usability by further standardizing internal parts, meets international standards, and addresses environmental and energy-saving issues.

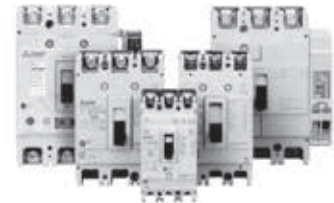

◆ Features

◆ Some models have a 54-mm-wide compact body, which belongs to the smallest class in the industry, by adopting the new "arc run breaking method".*1

While keeping the breaking capability, the new compact breaker contributes to downsizing of the enclosure and the mechanical equipment.

*1 Adopted for the F Style 32-A and 63-A frames.

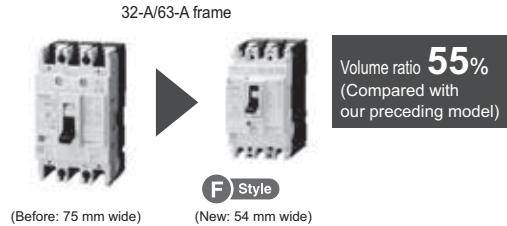
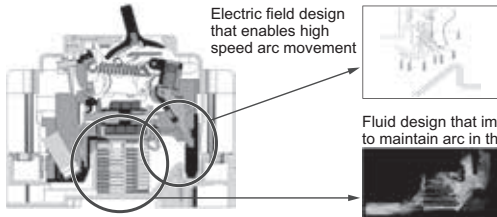

◆ Significant downsizing

When multiple units are used, the width becomes significantly smaller.

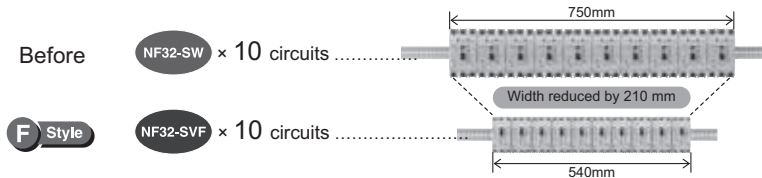

◆ Conforms to various global standards

- New JIS standard: JIS C 8201-2-1 (NF) Annex 1 and Annex 2
- Electrical Appliances and Materials Safety Act (PSE)
- IEC standard: IEC 60947-2
- EN (Europe): EN 60947-2, CE marking (TÜV certification, self declaration)
- GB standard (China): GB/T 14048.2 CCC certification
- Safety certification (Korea): KC marking



◆ Three-phase power supply supported by CE/CCC marked earth leakage circuit breakers

GB/T 14048.2-2008 was established in China, requiring the earth leakage circuit breaker to fulfill its function even if a phase is lost as is the case with the EN standard in Europe. CE/CCC marked earth leakage circuit breakers of the WS-V series support three phase power supply. Compliance with the revised standard is certified.

◆ Lineup of UL 489 listed circuit breakers with 54 mm width "Small Fit" **F Style**

The compact breakers contribute to a size reduction of machines, and IEC 35 mm rail mounting is standard.

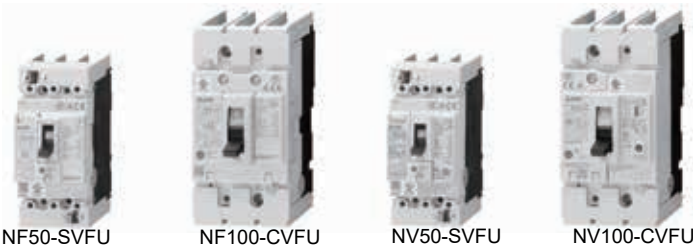

For security and standard compliance of machines, F-type and V-type operating handles are available for breakers with 54 mm width.

◆ Lineup of UL 489 listed circuit breakers for 480 V AC "High Performance"

The breaking capacity has been improved to satisfy the request for SCCR upgrading.

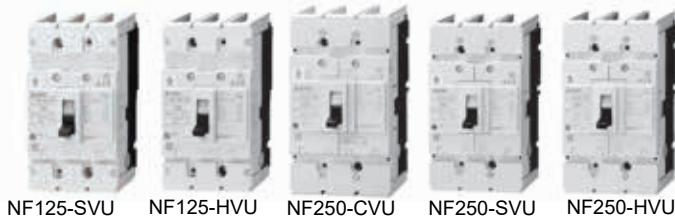

Breaking capacity of UL 489 listed circuit breakers for 480 V AC (UL 489) (Example of 240 V AC)

NF125-SVU/NV125-SVU	50 kA
NF125-HVU/NV125-HVU	100 kA
NF250-CVU/NV250-CVU	35 kA
NF250-SVU/NV250-SVU	65 kA
NF250-HVU/NV250-HVU	100 kA

Mitsubishi Electric Magnetic Motor Starters and Magnetic Contactors MS-T Series

Mitsubishi Electric magnetic motor starters have been newly designed and the MS-T series has been released. The MS-T series is smaller than ever, enabling more compact control panel. The MS-T series is suitable for other Mitsubishi Electric FA equipment. In addition, the MS-T conforms to a variety of global standards, supporting the global use.



◆ Features

◆ Compact

The width of the 10 A-frame model is as small as 36 mm.











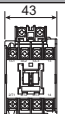
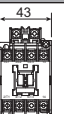
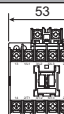

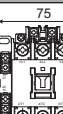
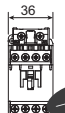
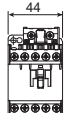
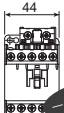

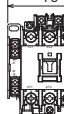
General-purpose magnetic contactor with smallest width*1 in the industry.

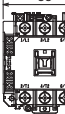
The width of MS-T series is reduced by 32% as compared to the prior MS-N series, enabling a more compact panel.

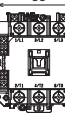
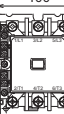
For selection, refer to **page 90**.

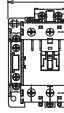
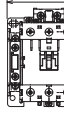
*1 Based on Mitsubishi Electric research as of November 2019 in the general-purpose magnetic contactor industry for 10 A-frame class.

[Unit: mm]

Frame size	11A	13A		20A		25A	32A
MS-N series	 S-N10	 S-N11 (Auxiliary 1-pole)	 S-N12 (Auxiliary 2-pole)	 S-N20	 S-N25	None	
New MS-T series	 S-T10 -7mm!	 S-T12 (Auxiliary 2-pole) -9mm!		 S-T20 -19mm!		 S-T25 -12mm!	 S-T32 New
Frame size	35A	50A		65A		80A	100A
MS-N series	 S-N35	 S-N50	 S-N50AE	 S-N65	 S-N65AE	 S-N80	 S-N95
New MS-T series	 S-T35	 S-T50 -13mm!		 S-T65		 S-T80 -12mm!	 S-T100

◆ Standardization

- Terminal covers are provided as standard to ensure safety inside the enclosure. Users do not have to make arrangements to specify and obtain options separately. Covers are provided also for the auxiliary contact unit. Users can reduce their inventory.

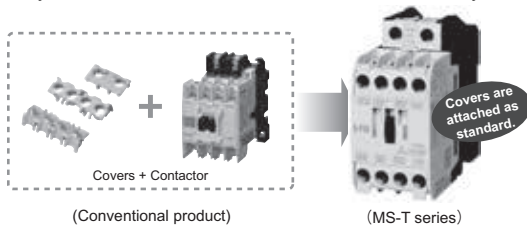

- Widened range of operation coil ratings (AC operated model) The widened range reduces the number of operation coil rating types from 13 (MS-N series) to 7. The reduced number of the operation coil types enables more simplified customers' ordering process and the faster delivery.
- Customers can select the operation coil more easily.

Coil designation	Rated voltage [V]	
	50 Hz	60 Hz
24 VAC	24	24
48 VAC	48 to 50	48 to 50
100 VAC	100	100 to 110
120 VAC	110 to 120	115 to 120
127 VAC	125 to 127	127
200 VAC	200	200 to 220
220 VAC	208 to 220	220
230 VAC	220 to 240	230 to 240
280 VAC	240 to 280	260 to 280
380 VAC	346 to 380	380
400 VAC	380 to 415	400 to 440
440 VAC	415 to 440	460 to 480
500 VAC	500	500 to 550



Coil designation	Rated voltage [V]
50 Hz/60 Hz	
24 VAC	24
48 VAC	48 to 50
100 VAC	100 to 127
200 VAC	200 to 240
300 VAC	260 to 300
400 VAC	380 to 440
500 VAC	460 to 550

Integrated coil ratings facilitate selection!

*Seven types are available without change for the 50 A frame model or higher.

◆ Global Standard

- Conforms to various global standards Our magnetic contactors are certified as compliant not only with major international standards such as IEC, JIS, UL, CE, and CCC but also with ship classification standards and country specific standards. This will help our customers expand their business overseas.

Standard	Applicable Standard				Safety Standard	
	International	Japan	Europe	China	U.S.A./ Canada	
	IEC*2	JIS	EN	Certification body	GB	cULus
			EC Directive			
						

*2 The MS-T series also provide safe isolation (mirror contact) specified in the IEC standard.

● Spring Clamp Terminal Models Available for Mitsubishi Electric Magnetic Contactor and Magnetic Relay

Spring clamp terminal:

Easy-to-connect terminal that ensures connection with the contact pressure of the spring just by pushing wire into the conductive terminal. Solid wires and ferrules can be connected simply by inserting them into the terminals.

Stranded wires can be connected by opening the spring with a tool, inserting wire, and removing the tool.



◆ Features

Key features of the screwless terminals:

- Significant reduction in the time required for wiring
Comparison with the terminal screw model (with round crimp terminal)
Wiring with ferrules: 22% reduction
Wiring with solid or stranded wire: 52% reduction
Reduction in the time required for wiring

Wiring performed by non-experts (with 2-year experience) (The research conducted by Japan Switchboard & control system Industries Association)

- Easy wiring for whoever works on
Push-in connection eliminates the need for the screw-tightening skills.
- Enhanced maintenance efficiency
Screw retightening is not necessary for installation and maintenance of enclosures and machines.
- Reliable wire connection
There is no risk of terminal screw loosening due to vibration or shocks, or long-term service.

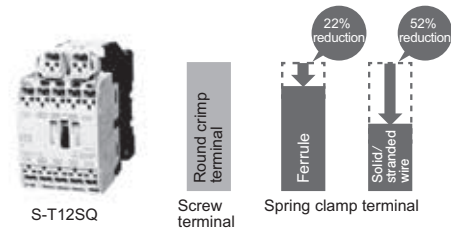

● Motor Circuit Breaker MMP-T Series

Motor circuit protection (against overload / phase loss / short-circuit) is achievable the MMP-T series alone. The wire-saving, space-saving design enables downsizing of the enclosure. The MMP-T series can be used in combination with the MS-T series .



MMP-T32

◆ Features

◆ What is the motor circuit breaker?

The motor circuit breaker, applicable to the motor circuit, has the functions of a circuit breaker and a thermal overload relay in one unit. The motor circuit breaker provides protection against overload, phase loss, and short circuit.

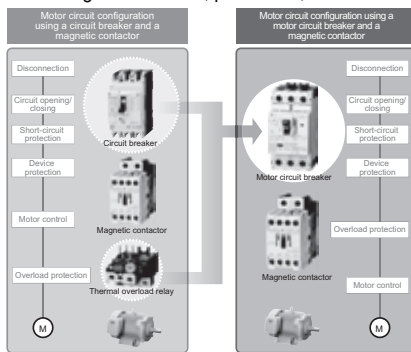

◆ Space-saving design for downsizing of the enclosure

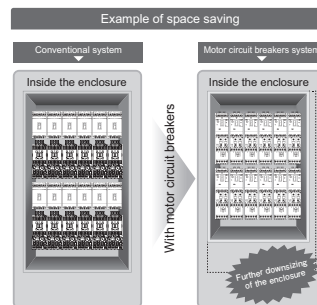

◆ Wire saving

Using a connection conductor unit (option) for connecting a motor circuit breaker and a contactor reduces work hours required for wiring. A connection conductor unit for the high sensitivity contactor (SD-Q) is also available. (Model: UT-MQ12)

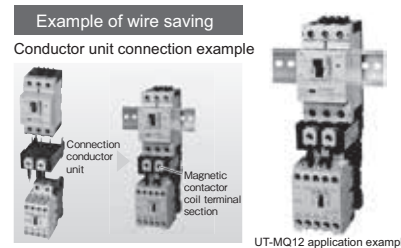

◆ Compliance to major standards support customers' overseas business

- Compliance with major global standards
Not only major international standards such as IEC, JIS, UL, CE, and CCC but also other national standards are certified. This will help our customers expand their business in foreign countries.

Standard	Applicable Standard				Safety Standard	
	International	Japan	Europe	China	U.S.A./ Canada	
	IEC	JIS	EN	Certification body	GB	cULus
			EC Directive			
CE	TÜV Rheinland	CCC				

- UL60947-4-1A Type E/F is also covered.
Compliance of the device to UL's Type E/F combination can surely support export to the United States.

● Selecting the rated sensitivity current for the earth leakage circuit breaker

When using an earth leakage circuit breaker with the inverter circuit, select its rated sensitivity current as follows, independently of the PWM carrier frequency.

- Breaker designed for harmonic and surge suppression

Rated sensitivity current

$$I\Delta n \geq 10 \times (I_{g1} + I_{gn} + I_{gi} + I_{g2} + I_{gm})$$

- Standard breaker

Rated sensitivity current

$$I\Delta n \geq 10 \times \{I_{g1} + I_{gn} + I_{gi} + 3 \times (I_{g2} + I_{gm})\}$$

I_{g1} , I_{g2} : Leakage currents in wire path during commercial power supply operation

I_{gn} : Leakage current of inverter input side noise filter

I_{gm} : Leakage current of motor during commercial power supply operation

I_{gi} : Leakage current of inverter unit

Example of leakage current of cable path per 1 km during the commercial power supply operation when the CV cable is routed in metal conduit (200 V 60 Hz)

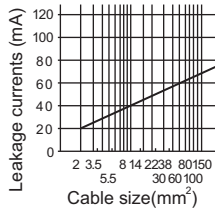

Leakage current example of three-phase induction motor during the commercial power supply operation (200 V 60 Hz)

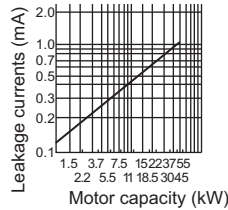

Example of leakage current per 1 km during the commercial power supply operation when the CV cable is routed in metal conduit

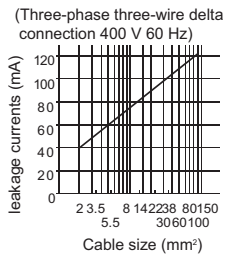

Leakage current example of three-phase induction motor during the commercial power supply operation

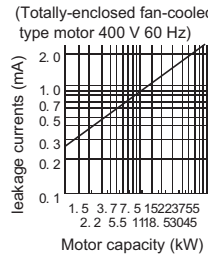

For "Δ" connection, the amount of leakage current is approx. 1/3 of the above value.

<Example>

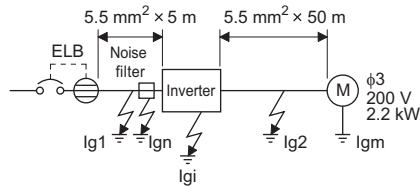

- Install the earth leakage circuit breaker (ELB) on the input side of the inverter.
- In the Δ connection earthed-neutral system, the sensitivity current is blunt against a ground fault in the inverter output side. Earthing (Grounding) must conform to the requirements of national and local safety regulations and electrical codes. (NEC section 250, IEC 61140 class 1 and other applicable standards)

◆ Selection example (in the case of the above figure)

	Breaker designed for harmonic and surge suppression	Standard breaker
Leakage current I_{g1} (mA)	$33 \times \frac{5 \text{ m}}{1000 \text{ m}} = 0.17$	
Leakage current I_{gn} (mA)	0	
Leakage current I_{gi} (mA)	1	
Leakage current I_{g2} (mA)	$33 \times \frac{50 \text{ m}}{1000 \text{ m}} = 1.65$	
Motor leakage current I_{gm} (mA)	0.18	
Total leakage current (mA)	3.00	6.66
Rated sensitivity current (mA) ($\geq I_g \times 10$)	30	100

● Molded case circuit breaker, magnetic contactor, cable gauge

Voltage	Motor output (kW) *1	Applicable inverter model (ND rating)	Molded case circuit breaker (MCCB) *2 or earth leakage circuit breaker (ELB) (NF, NV type)		Input side magnetic contactor *3		Recommended cable gauge (mm ²) *4		
			Power factor improving (AC or DC) reactor connection		Power factor improving (AC or DC) reactor connection		R/L1, S/L2, T/L3		U, V, W
			Without	With	Without	With	Without	With	
200 V	0.1	FR-E820-0008(0.1K)	5A	5A	S-T10	S-T10	2	2	2
	0.2	FR-E820-0015(0.2K)	5A	5A	S-T10	S-T10	2	2	2
	0.4	FR-E820-0030(0.4K)	5A	5A	S-T10	S-T10	2	2	2
	0.75	FR-E820-0050(0.75K)	10A	10A	S-T10	S-T10	2	2	2
	1.5	FR-E820-0080(1.5K)	15A	15A	S-T10	S-T10	2	2	2
	2.2	FR-E820-0110(2.2K)	20A	15A	S-T10	S-T10	2	2	2
	3.7	FR-E820-0175(3.7K)	30A	30A	S-T21	S-T10	3.5	3.5	3.5
	5.5	FR-E820-0240(5.5K)	50A	40A	S-T35	S-T21	5.5	5.5	5.5
400 V	0.4	FR-E840-0016(0.4K)	5A	5A	S-T10	S-T10	2	2	2
	0.75	FR-E840-0026(0.75K)	5A	5A	S-T10	S-T10	2	2	2
	1.5	FR-E840-0040(1.5K)	10A	10A	S-T10	S-T10	2	2	2
	2.2	FR-E840-0060(2.2K)	15A	10A	S-T10	S-T10	2	2	2
	3.7	FR-E840-0095(3.7K)	20A	15A	S-T10	S-T10	2	2	2
	5.5	FR-E840-0120(5.5K)	30A	20A	S-T21	S-T12	3.5	2	2
	7.5	FR-E840-0170(7.5K)	30A	30A	S-T21	S-T21	3.5	3.5	3.5
575 V	0.75	FR-E860-0017(0.75K)	5A	5A	3A	3A	2	2	2
	1.5	FR-E860-0027(1.5K)	10A	5A	5A	3A	2	2	2
	2.2	FR-E860-0040(2.2K)	10A	10A	7A	5A	2	2	2
	3.7	FR-E860-0061(3.7K)	15A	10A	10A	7A	2	2	2
	5.5	FR-E860-0090(5.5K)	20A	15A	15A	10A	2	2	2
	7.5	FR-E860-0120(7.5K)	30A	20A	21A	15A	3.5	2	2

*1 Assumes the use of a 4-pole standard motor.

*2 Select an MCCB according to the power supply capacity. Install one MCCB per inverter.

(For the use in the United States or Canada, refer to "Instructions for UL and cUL" in the Instruction Manual (Connection), and select an appropriate fuse or molded case circuit breaker (MCCB).)

*3 The magnetic contactor is selected based on the AC-1 class. The electrical durability of magnetic contactor is 500,000 times. When the magnetic contactor is used for emergency stops during motor driving, the electrical durability is 25 times.

If using an MC for emergency stop during motor driving or using it on the motor side during commercial power supply operation, select an MC with the class AC-3 rated current for the rated motor current.

*4 Cables

The gauge of the cable with the continuous maximum permissible temperature of 90°C or higher. (LMFC (heat resistant flexible cross-linked polyethylene insulated cable), etc.). It assumes a surrounding air temperature of 40°C or lower and in-enclosure wiring.

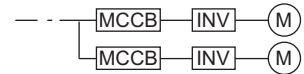

NOTE

- When the inverter capacity is larger than the motor capacity, select an MCCB and a magnetic contactor according to the inverter model, and select cables and reactors according to the motor output.
- When the breaker on the inverter's input side trips, check for the wiring fault (short circuit), damage to internal parts of the inverter etc. The cause of the trip must be identified and removed before turning ON the power of the breaker.

MEMO

Precaution on Selection and Operation

● Precautions for use

◆ Safety instructions

- To use the product safely and correctly, make sure to read the "Instruction Manual" before the use.
- This product has not been designed or manufactured for use with any equipment or system operated under life-threatening conditions.
- Please contact our sales representative when considering using this product in special applications such as passenger mobile, medical, aerospace, nuclear, power or undersea relay equipment or system.
- Although this product was manufactured under conditions of strict quality control, install safety devices to prevent serious accidents when it is used in facilities where breakdowns of the product or other failures are likely to cause a serious accident.
- Do not use the inverter for a load other than the three-phase induction motor and the PM motor.
- Do not connect a IPM motor in the induction motor control settings (initial settings). Do not use an induction motor in the IPM sensorless vector control settings. It will cause a failure.

◆ Operation

- When a magnetic contactor (MC) is installed on the input side, do not use the MC for frequent starting/stopping. Otherwise the inverter may be damaged.
- When a fault occurs in the inverter, the protective function is activated to stop the inverter output. However, the motor cannot be immediately stopped. For machinery and equipment that require an immediate stop, provide a mechanical stop/holding mechanism.
- Even after turning OFF the inverter, it takes time to discharge the capacitor. Before performing an inspection, wait 10 minutes or longer after the power supply turns OFF, then check the voltage using a tester, etc.

◆ Wiring

- Applying the power to the inverter output terminals (U, V, W) causes a damage to the inverter. Before power-on, thoroughly check the wiring and sequence to prevent incorrect wiring, etc.
- Terminals P/+, P1, N/-, and PR are the terminals to connect dedicated options. Do not connect any device other than the dedicated options. Do not short-circuit between the frequency setting power supply terminal 10 and the common terminal 5, and between terminals PC and SD.
- To remove the wire connected to the control circuit terminal, pull the wire while pressing down the open/close button firmly with a flathead screwdriver. Otherwise, the terminal block may be damaged.
- To prevent a malfunction due to noise, keep the signal cables 10cm or more away from the power cables. Also, separate the main circuit cables at the input side from the main circuit cables at the output side.
- After wiring, wire offcuts must not be left in the inverter. Wire offcuts can cause an alarm, failure or malfunction. Always keep the inverter clean. When drilling mounting holes in an enclosure etc., take caution not to allow chips and other foreign matter to enter the inverter.
- Set the voltage/current input switch correctly. Incorrect setting may cause a fault, failure or malfunction.

◆ Power supply

- When the inverter is connected near a large-capacity power transformer (500 kVA or more) or when a power factor correction capacitor is to be switched over, an excessive peak current may flow in the power input circuit, damaging the inverter. To prevent this, always install an optional AC reactor (FR-HAL).
- If surge voltage occurs in the power supply system, this surge energy may flow into an inverter, and the inverter may display the overvoltage protection (E. OV[]) and trip. To prevent this, install an optional AC reactor (FR-HAL).

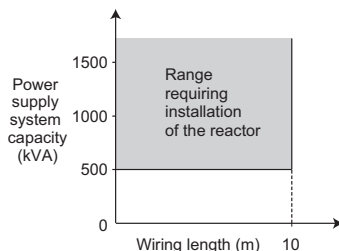

◆ Installation

- Install the inverter in a clean place with no floating oil mist, cotton fly, dust and dirt, etc. Alternatively, install the inverter inside the "sealed type" enclosure that prevents entry of suspended substances. For installation in the enclosure, decide the cooling method and the enclosure size to keep the surrounding air temperature of the inverter/the converter unit within the permissible range (for specifications, refer to **page 58**).
- Some parts of the inverter/the converter unit become extremely hot. Do not install the inverter to inflammable materials (wood etc.).
- Attach the inverter vertically.

◆ Setting

- Depending on the parameter setting, high-speed operation (up to 590 Hz) is available. Incorrect setting will lead to a dangerous situation. Set the upper limit by using the upper frequency limit setting.
- Setting the DC injection brake operation voltage and operating time larger than their initial values causes motor overheating (electronic thermal O/L relay trip).
- Do not set **Pr. 70 Special regenerative brake duty** except for using the optional brake resistor. This function is used to protect the brake resistor from overheating. Do not set the value exceeding permissible duty of the brake resistor.

◆ Real sensorless vector control

- Under Real sensorless vector control, always execute offline auto tuning before starting operations.
- The speed command setting range under Real sensorless vector control is 0 to 400 Hz.
- The selectable carrier frequencies under Real sensorless vector control are 2, 6, 10, and 14 kHz.
- Torque control is not available in the low-speed (about 10 Hz or less) regenerative range, or in the low speed with the light load (about 5 Hz or less with about 20% or less of the rated torque).
- The motor may start running at a low speed even when the start signal (STF or STR) is not input. The motor may run also at a low speed when the speed limit value = 0 with a start command input. Confirm that the motor running does not cause any safety problems. Under torque control, do not switch between the forward rotation command (STF) and reverse rotation command (STR). The overcurrent trip (E. OC[]) or opposite rotation deceleration fault (E.11) occurs.
- If the inverter may restart during coasting under Real sensorless vector control, set the automatic restart after instantaneous power failure function to enable frequency search (**Pr.57** ≠ "9999", **Pr.162** = "10").
- Under Real sensorless vector control, sufficient torque may not be obtained in the extremely low-speed range of about 2 Hz or less.
- The approximate speed control range is as described below.
Power drive: 1:200 (2, 4, 6 poles), 0.3 Hz or more for 60 Hz rating.
1:30 (8, 10 poles), 2 Hz or more for 60 Hz rating
Regenerative driving: 1:12 (2 to 10 poles), 5 Hz or more for 60 Hz rating

● IPrecautions for use of IPM motor

When using the IPM motor, the following precautions must be observed as well.

◆ ⚠ Safety instructions

- Do not use an IPM motor for an application where the motor is driven by the load

◆ Combination of motor and inverter

- For the motor capacity, the rated motor current should be equal to or less than the rated inverter current. (Note that the motor rated current should be 0.4 kW or higher (0.1 kW or higher for the 200 V class).) If a motor with substantially low rated current compared with the inverter rated current is used, speed and torque accuracies may deteriorate due to torque ripples, etc. Set the rated motor current to about 40% or higher of the inverter rated current.
- Only one IPM motor can be connected to an inverter.
- An IPM motor cannot be driven by the commercial power supply.

◆ Installation

- While power is ON or for some time after power-OFF, do not touch the motor since the motor may be extremely hot. Touching these devices may cause a burn.

◆ Wiring

- Applying the commercial power supply to input terminals (U, V, W) of a motor will burn the motor. The motor must be connected with the output terminals (U, V, W) of the inverter.
- An IPM motor is a motor with permanent magnets embedded inside. High voltage is generated at the motor terminals while the motor is running. Before wiring or inspection, confirm that the motor is stopped. In an application, such as a fan or blower, where the motor is driven by the load, a low-voltage manual contactor must be connected at the inverter's output side, and wiring and inspection must be performed while the contactor is open. Otherwise an electric shock may be caused. The inverter power must be turned ON before closing the contacts of the contactor at the output side.
- Match the input terminals (U, V, W) of the motor and the output terminals (U, V, W) of the inverter when connecting.
- Use the following length of wiring or shorter when connecting an IPM motor.

◆ Operation

- About 0.1 s (magnetic pole detection time) takes to start a motor after inputting a start signal.
- An IPM motor is a motor with embedded permanent magnets. Regressive voltage is generated when the motor coasts at an instantaneous power failure or other incidents. The inverter's DC bus voltage increases if the motor coasts fast in this condition. When using the automatic restart after instantaneous power failure function, it is recommended to also use the regeneration avoidance operation to make startups stable.
- Thus, the relation between the rotation speed and the frequency setting is:
Rotation speed = 120 × frequency setting value / number of motor poles

◆ Connection with machine

◆ Direct connection

- When installing, align the motor shaft center and the machine shaft. Insert a liner underneath the motor or the machine legs as required to make a perfect alignment.

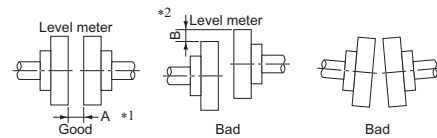

- *1 Set so that the A dimensions become the same dimension even when any position is measured by feeler gauge. (inequality in A width 3/100 mm or lower)
- *2 Do not set parts with a vertical gap like B (maximum runoff degree: 3/100 mm).

NOTE

- When a fan or blower is directly connected to the motor shaft or to the machine, the machine side may become unbalanced. When the unbalanced degree becomes larger, the motor vibration becomes larger and may result in a damage of the bearing or other area. The balance quality with the machine should meet the class G2.5 or lower of JISB0905 (the Balance Quality Requirements of Rigid Rotors).
- ◆ Connected by belt
 - When installing, place the motor shaft and the machine shaft in parallel, and mount them to a position where their pulley centers are aligned. Their pulley centers should also have a right angle to each shaft.
 - An excessively stretched belt may damage the bearing and break the shafts. A loose belt may slip off and easily deteriorate. A flat belt should be rotated lightly when it is pulled by one hand. For details, refer to the Instruction Manual of the motor.
- ◆ Connected by gear couplings
 - Place the motor and machine shafts in parallel, and engage the gear teeth properly.

◆ Permissible vibration during operation

During operation, the motor coupled to a load machine may vibrate according to the degree of coupling between the motor and the load, and the degree of vibration created by the load. The degree of the motor's vibration varies depending on the condition of the foundations and baseplate of the motor. If the motor has higher vibration than the permissible level, investigate the cause, take measure, and take action.

● Selection precautions

◆ Inverter capacity selection

- When operating a special motor or multiple motors in parallel by one inverter, select the inverter capacity so that 1.05 times of the total of the rated motor current becomes less than the rated output current of the inverter.
(Multiple PM motors cannot be connected to an inverter.)
- Do not set **Pr. 70 Special regenerative brake duty** except for using the optional brake resistor. This function is used to protect the brake resistor from overheating. Do not set the value exceeding permissible duty of the brake resistor.

◆ Starting torque of the motor

- The starting and acceleration characteristics of the motor driven by an inverter are restricted by the overload current rating of the inverter. In general, the torque characteristic has small value compared to when the motor is started by a commercial power supply. When a large starting torque is required, and torque boost adjustment, Advanced magnetic flux vector control and Real sensorless vector control cannot generate the sufficient torque, increase both the motor and inverter capacities.

◆ Acceleration/deceleration time

- The motor acceleration/deceleration time is decided by the torque generated by the motor, load torque, and moment of inertia (J) of load.
- The required time may increase when the torque limit function or stall prevention function operates during acceleration/deceleration. In such a case, set the acceleration/decelerations time longer.
- To decrease the acceleration/deceleration time, increase the torque boost value (setting of a too large value may activate the stall prevention function at a start, longer the acceleration time), use the advanced magnetic flux vector control or real sensorless vector control or increase the inverter and motor capacities. To decrease the deceleration time, it is necessary to add optional brake resistor MRS type, MYS type, or FR-ABR (for the 0.4K or higher), the brake unit (FR-BU2), multifunction regeneration converter (FR-XC), or a similar device to absorb braking energy.

◆ Power transfer mechanisms (reduction gear, belt, chain, etc.)

- Caution is required for the low-speed continuous operation of the motor with an oil lubricated gear box, transmission, reduction gear, etc. in the power transfer mechanism. Such an operation may degrade the oil lubrication and cause seizing. On the other hand, the high-speed operation at more than 60 Hz may cause problems with the noise of the power transfer mechanism, life, or insufficient strength due to centrifugal force, etc. Fully take necessary precautions.

◆ Instructions for overload operation

- When performing frequent starts/stops by the inverter, rise/fall in the temperature of the transistor element of the inverter will repeat due to a repeated flow of large current, shortening the life from thermal fatigue. Since thermal fatigue is related to the amount of current, the life can be increased by reducing current at locked condition, starting current, etc. Reducing current may extend the service life but may also cause torque shortage, which leads to a start failure. Adding a margin to the current can eliminate such a condition. For an induction motor, use an inverter of a higher capacity (up to two ranks for the ND rating). For an PM motor, use an inverter and PM motor of higher capacities.

● Precautions on peripheral device selection

◆ Selection and installation of molded case circuit breaker

Install a molded case circuit breaker (MCCB) on the power receiving side to protect the wiring at the inverter input side. Select an MCCB according to the inverter power supply side power factor, which depends on the power supply voltage, output frequency and load. Refer to **page 90**. Especially for a completely electromagnetic MCCB, a slightly large capacity must be selected since its operation characteristic varies with harmonic currents. (Check the reference material of the applicable breaker.) As an earth leakage circuit breaker, use the Mitsubishi Electric earth leakage circuit breaker designed for harmonics and surge suppression. (Refer to **page 89**.)

When installing a molded case circuit breaker on the inverter output side, contact the manufacturer of each product for selection.

◆ Handling of the input side magnetic contactor (MC)

- For the operation using external terminals (using terminal STF or STR), install the input-side magnetic contactor to prevent accidents due to automatic restart when the power is restored after power failures such as an instantaneous power failure, or for safety during maintenance works. Do not use this magnetic contactor for frequent starting/stopping of the inverter. (The switching life of the converter part is about 1 million times.) In the operation by parameter unit, the automatic restart after power restoration is not performed and the magnetic contactor cannot be used to start the motor. The input-side magnetic contactor can stop the motor. However, the regenerative brake of the inverter does not operate, and the motor coasts to a stop.
- Installation of a magnetic contactor at the input side is recommended. A magnetic contactor avoids overheat or burnout of a brake resistor when heat capacity of the resistor is insufficient or a brake regenerative transistor is damaged with short while connecting an optional brake resistor. In this case, shut-off the magnetic contactor when fault occurs and inverter trips.

◆ Handling of the output side magnetic contactor (MC)

- Switch the MC between the inverter and motor only when both the inverter and motor are at a stop. When the magnetic contactor is turned ON while the inverter is operating, overcurrent protection of the inverter and such will activate. When an MC is provided to switch to a commercial power supply, switch it ON/OFF after the inverter and motor have stopped.
- Do not install a magnetic contactor at the inverter's output side when using a PM motor.

◆ Installation of thermal relay

In order to protect the motor from overheating, the inverter has an electronic thermal O/L relay. However, install an external thermal overcurrent relay (OCR) between the inverter and motors to operate several motors or a multi-pole motor with one inverter. In this case, set 0 A to the electronic thermal O/L relay setting of the inverter. For the external thermal overcurrent relay, determine the setting value in consideration of the current indicated on the motor's rating plate and the line-to-line leakage current. (**Refer to page 96.**)

Self cooling ability of a motor reduces in the low-speed operation. Installation of a thermal protector or a use of a motor with built-in thermistor is recommended.

◆ Output side measuring instrument

When the inverter-to-motor wiring length is long, especially for the 400 V class, small-capacity models, the meters and CTs may generate heat due to line-to-line leakage current. Therefore, choose the equipment which has enough allowance for the current rating.

When measuring and displaying the output voltage and output current of the inverter, use of terminals AM and 5 output function of the inverter is recommended.

◆ **Disuse of power factor improving capacitor (power factor correction capacitor)**

The power factor improving capacitor and surge suppressor on the inverter output side may be overheated or damaged by the harmonic components of the inverter output. Also, since an excessive current flows in the inverter to activate overcurrent protection, do not provide a capacitor and surge suppressor. To improve the power factor, use an AC reactor (on page 39), a DC reactor (on page 40), or a high power factor converter (on page 55).

◆ **Electrical corrosion of the bearing**

When a motor is driven by the inverter, axial voltage is generated on the motor shaft, which may cause electrical corrosion of the bearing in rare cases depending on the wiring, load, operating conditions of the motor or specific inverter settings (high carrier frequency, use of a capacitive filter *1). Contact your sales representative to take appropriate countermeasures for the motor.

The following shows examples of countermeasures for the inverter.

- Decrease the carrier frequency.
- Remove the capacitive filter.
- Provide a common mode choke on the output side of the inverter.*2

(This is effective regardless of the use of the capacitive filter.)

- *1 Mitsubishi Electric capacitive filter: FR-BIF, SF[], FR-E5NF-[], FR-S5NFSA[], FR-BFP2-[]
- *2 Recommended common mode choke: FT-3KM F series FINEMET® common mode choke cores manufactured by Hitachi Metals, Ltd. FINEMET is a registered trademark of Hitachi Metals, Ltd.

◆ **Cable gauge and wiring distance**

If the wiring distance is long between the inverter and motor, during the output of a low frequency in particular, use a large cable gauge for the main circuit cable to suppress the voltage drop to 2% or less. (The table on page 90 indicates a selection example for the wiring length of 20 m.)

Especially for long-distance wiring or wiring with shielded cables, the inverter may be affected by a charging current caused by stray capacitances of the wiring, leading to an incorrect activation of the overcurrent protective function. Refer to the maximum wiring length shown in the following table.

When multiple motors are connected, use the total wiring length shown in the table or shorter

Cable type	Pr.72 setting (carrier frequency)	Voltage class	0.1K	0.2K	0.4K	0.75K	1.5 K	2.2 K	3.7K or higher
Unshielded	1 (1 kHz) or lower	200V	200	200	300	500	500	500	500
		400V	-	-	200	300	500	500	500
Unshielded	2 (2 kHz) or lower	200V	30	100	200	300	500	500	500
		400V	-	-	30	100	200	300	100
Shielded	1 (1 kHz) or lower	200V	50	50	75	100	100	100	100
		400V	-	-	50	50	75	100	100
Shielded	2 (2 kHz) or lower	200V	10	25	50	75	100	100	100
		400V	-	-	10	25	50	75	100

When using the automatic restart after instantaneous power failure function with wiring length exceeding 100m, select without frequency search (Pr. 162 = "1, 11").

When the operation panel is installed away from the inverter and when the parameter unit is connected, use a recommended connection cable.

For the remote operation using analog signals, keep the control cable distance between the operation signal transmitter and the inverter to 30 m or less. Also, to prevent induction from other devices, keep the wiring away from the power circuits (main circuit and relay sequential circuit).

When the frequency setting is performed using the external potentiometer, not using the parameter unit, use a shielded or twisted cable as shown in the figure below. Connect the shield cable to terminal 5, not to the earth (ground).

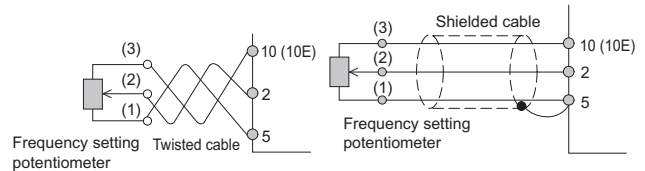

◆ **Earth (ground)**

When the inverter is set for the low acoustic noise operation, the leakage current increases compared to in the normal operation due to the high speed switching operation. Always earth (ground) the inverter and the motor. Also, always use the earth (ground) terminal of the inverter for earthing (grounding). (Do not use a case or chassis.)

◆ Electromagnetic interference (EMI)

For the low acoustic noise operation with high carrier frequency, electromagnetic noise tends to increase. Take countermeasures by referring to the following examples. Depending on an installation condition, noise may affect the inverter also in the normal operation (initial status).

- Decrease the carrier frequency (**Pr.72**) setting to lower the EMI level.
- As measures against AM radio broadcasting noise, radio noise filter FR-BIF produces an effect.
- As measures against sensor malfunction, line noise filter FRBSF01, FR-BLF produces an effect.
- For effective reduction of induction noise from the power cable of the inverter, secure the distance of 30 cm (at least 10 cm) from the power line and use a shielded twisted pair cable for the signal cable. Do not earth (ground) the shield, and connect the shield to a common terminal by itself.

EMI measure example

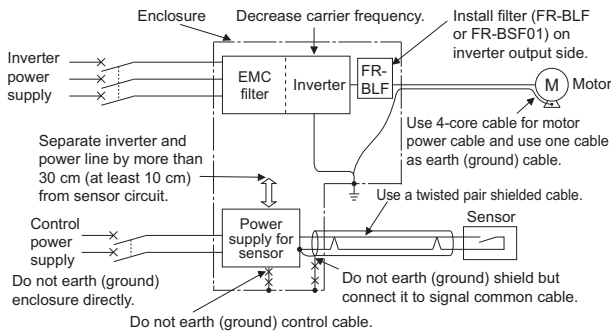

◆ Line-to-line leakage current

Type	Influence and countermeasure
Influence and countermeasure	<ul style="list-style-type: none"> • Line-to-line leakage current flows through the capacitance between the inverter/the converter unit output lines. • Harmonic component of the leaked current may cause unnecessary operation of an external thermal relay. Long wiring length (50 m or longer) for the 400V class small capacity models (7.5 kW or lower) will increase the rate of leakage current against the rated motor current. In such a case, an unnecessary operation of the external thermal relay may be more liable to occur. <p>Countermeasure</p> <ul style="list-style-type: none"> • Use Pr.9 Electronic thermal O/L relay. • If the carrier frequency setting is high, decrease the Pr.72 PWM frequency selection setting. However, the motor noise increases. Selecting Pr.240 Soft-PWM operation selection makes the sound inoffensive. <p>To protect motor securely without being subject to the influence of the line-to-line leakage current, direct detection of the motor temperature using a temperature sensor is recommended.</p>
Transmission path	

◆ leakage current

Capacitances exist between the inverter unit I/O cables and other cables or the earth, and within the motor, through which a leakage current flows. Since its value depends on the static capacitances, carrier frequency, etc., low acoustic noise operation at the increased carrier frequency of the inverter will increase the leakage current. Therefore, take the following countermeasures. Select the earth leakage circuit breaker according to its rated sensitivity current, independently of the carrier frequency setting.

◆ To-earth (ground) leakage currents

Type	Influence and countermeasure
Influence and countermeasure	<ul style="list-style-type: none"> • Leakage currents may flow not only into the inverter own line but also into the other lines through the earthing (grounding) cable, etc. These leakage currents may operate earth leakage circuit breakers and earth leakage relays unnecessarily. <p>Countermeasure</p> <ul style="list-style-type: none"> • If the carrier frequency setting is high, decrease the Pr.72 PWM frequency selection setting. However, the motor noise increases. Selecting Pr.240 Soft-PWM operation selection makes the sound inoffensive. • By using earth leakage circuit breakers designed for harmonic and surge suppression in the inverter's own line and other line, operation can be performed with the carrier frequency kept high (with low noise).
Transmission path	

◆ Harmonic Suppression Guidelines

Inverters have a converter section (rectifier circuit) and generate a harmonic current.

Harmonic currents flow from the inverter to a power receiving point via a power transformer. The Harmonic Suppression Guidelines was established to protect other consumers from these outgoing harmonic currents.

The three-phase 200 V input specifications 3.7 kW or lower were previously covered by the "Harmonic Suppression Guidelines for Household Appliances and General-purpose Products" and other models were covered by the "Harmonic Suppression Guidelines for Consumers Who Receive High Voltage or Special High Voltage". However, the general-purpose inverter has been excluded from the target products covered by the "Harmonic Suppression Guidelines for Household Appliances and General-purpose Products" in January 2004 and the "Harmonic Suppression Guideline for Household Appliances and General-purpose Products" was repealed on September 6, 2004.

All capacity and all models of general-purpose inverter used by specific consumers are now covered by the "Harmonic Suppression Guidelines for Consumers Who Receive High Voltage or Special High Voltage".

- "Harmonic Suppression Guidelines for Consumers Who Receive High Voltage or Special High Voltage"
This guideline sets the maximum values of outgoing harmonic currents generated from a high-voltage or specially high-voltage receiving consumer who will install, add or renew harmonic generating equipment. If any of the maximum values is exceeded, this guideline requires that consumer to take certain suppression measures.

The users who are not subjected to the above guidelines do not need follow the guidelines, but the users are recommended to connect a DC reactor and an AC reactor as usual.

Compliance with the "Harmonic Suppression Guidelines for Consumers Who Receive High Voltage or Special High Voltage"

Input power	Target capacity	Countermeasure
Three-phase 200 V	All capacities	Confirm the compliance with the "Harmonic Suppression Guidelines for Consumers Who Receive High Voltage or Special High Voltage" published in September 1994 by the Ministry of International Trade and Industry (the present Japanese Ministry of Economy, Trade and Industry). Take countermeasures if required. Use the following materials as reference to calculate the power supply harmonics. Reference materials "Harmonic Suppression Measures of the General-purpose Inverter" January 2004, Japan Electrical Manufacturers' Association "Calculation Method of Harmonic Current of the General-purpose Inverter Used by Specific Consumers" JEM-TR201 (Revised in December 2003), Japan Electrical Manufacturers' Association
Three-phase 400 V		

For compliance to the "Harmonic Suppression Guideline of the General-purpose Inverter (Input Current of 20A or Less) for Consumers Other Than Specific Consumers" published by JEMA

Input power	Target capacity	Measures
Three-phase 200 V	3.7 kW or lower	Connect the AC reactor or DC reactor recommended in the Catalogs and Instruction Manuals. Reference materials "Harmonic Suppression Guideline of the General-purpose Inverter (Input Current of 20A or Less)" JEM-TR226 (Published in December 2003), Japan Electrical Manufacturers' Association

◆ Calculation of outgoing harmonic current

Outgoing harmonic current = fundamental wave current (value converted from received power voltage) × operation ratio × harmonic content

- Operation ratio: Operation ratio = actual load factor × operation time ratio during 30 minutes
- Harmonic content: Found in the table below.

- Harmonic contents (values when the fundamental wave current is 100%)

Reactor	5th	7th	11th	13th	17th	19th	23rd	25th
Not used	65	41	8.5	7.7	4.3	3.1	2.6	1.8
Used (AC side)	38	14.5	7.4	3.4	3.2	1.9	1.7	1.3
Used (DC side)	30	13	8.4	5.0	4.7	3.2	3.0	2.2
Used (AC, DC sides)	28	9.1	7.2	4.1	3.2	2.4	1.6	1.4

- Rated capacities and outgoing harmonic currents when driven by inverter

Applied motor(kW)	Fundamental wave current (A)		Fundamental wave current converted from 6.6 kV (mA)	Rated capacity(kVA)	Outgoing harmonic current converted from 6.6 kV (mA) (No reactor, 100% operation ratio)							
	200 V	400 V			5th	7th	11th h	13th h	17th h	19th h	23rd d	25th h
0.4	1.61	0.81	49	0.57	31.85	20.09	4.165	3.773	2.107	1.519	1.274	0.882
0.75	2.74	1.37	83	0.97	53.95	34.03	7.055	6.391	3.569	2.573	2.158	1.494
1.5	5.50	2.75	167	1.95	108.6	68.47	14.20	12.86	7.181	5.177	4.342	3.006
2.2	7.93	3.96	240	2.81	156.0	98.40	20.40	18.48	10.48	7.40	6.240	4.320
3.7	13.0	6.50	394	4.61	257.1	161.5	33.49	30.34	16.94	12.21	10.24	7.092
5.5	19.1	9.55	579	6.77	376.1	237.4	49.22	44.58	24.90	17.95	15.05	10.42
7.5	25.6	12.8	776	9.07	504.4	318.2	65.96	59.75	33.37	24.06	20.18	13.97
11	36.9	18.5	1121	13.1	728.7	459.6	95.29	86.32	48.20	34.75	29.15	20.18

- Conversion factors

Classification	Circuit type	Conversion coefficient Ki
3	Without reactor	K31 = 3.4
	With reactor (AC side)	K32 = 1.8
	With reactor (DC side)	K33 = 1.8
	With reactors (AC, DC sides)	K34 = 1.4
5	Self-excitation three-phase bridge	When a high power factor converter is used K5 = 0

Compatible Motors

● List of applicable inverter models by rating (motor capacity → inverter model)

◆ 200 V class

Motor capacity (kW)*1	DC reactor	LD			ND		
	FR-HEL-[]	Model FR-E820-[]		Rated current (A)	Model FR-E820-[]		Rated current (A)
0.1	0.4K*2	0.1K	0008	0.8	0.1K	0008	0.8
0.2	0.4K*2	0.1K	0008	0.8	0.2K	0015	1.5
0.4	0.4K	0.2K	0015	1.5	0.4K	0030	3
0.75	0.75K	0.4K	0030	3	0.75K	0050	5
1.1	1.5K	0.75K	0050	5	1.5K	0080	8
1.5	1.5K	1.5K	0080	8	1.5K	0080	8
2.2	2.2K	1.5K	0080	8	2.2K	0110	11
3	3.7K	2.2K	0110	11	3.7K	0175	17.5
3.7	3.7K	3.7K	0175	17.5	3.7K	0175	17.5
5.5	5.5K	3.7K	0175	17.5	5.5K	0240	24
7.5	7.5K	5.5K	0240	24	7.5K	0330	33
11	11K	7.5K	0330	33	-	-	-

◆ 400 V class

Motor capacity (kW)*1	DC reactor	LD			ND		
	FR-HEL-[]	Model FR-E840-[]		Rated current (A)	Model FR-E840-[]		Rated current (A)
0.4	H0.4K	0.4K	0016	1.6	0.4K	0016	1.6
0.75	H0.75K	0.4K	0016	1.6	0.75K	0026	2.6
1.5	H1.5K	0.75K	0026	2.6	1.5K	0040	4
2.2	H2.2K	1.5K	0040	4	2.2K	0060	6
3	H3.7K	2.2K	0060	6	3.7K	0095	9.5
3.7	H3.7K	3.7K	0095	9.5	3.7K	0095	9.5
5.5	H5.5K	3.7K	0095	9.5	5.5K	0120	12
7.5	H7.5K	5.5K	0120	12	7.5K	0170	17
11	H11K	7.5K	0170	17	-	-	-

*1 The applicable motor capacity indicated is the maximum capacity applicable for use of the Mitsubishi Electric 4-pole standard motor.

*2 The power factor may be slightly lower.

◆ Overload current rating

LD	120% 60 s, 150% 3 s (inverse-time characteristics) at surrounding air temperature of 50°C
ND	150% 60 s, 200% 3 s (inverse-time characteristics) at surrounding air temperature of 50°C

● **Application to constant-torque motors**

◆ **SF-HRCA type**

- Continuous operation even at low speed of 0.3 Hz is possible (when using Real sensorless vector control). For the 37 kW or lower (except for 22 kW), load torque is not needed to be reduced even at a low speed and constant torque (100% torque) continuous operation is possible within the range of speed ratio 1/20 (3 to 60 Hz). (The characteristic of motor running at 60 Hz or higher is that output torque is constant.)
- Installation size is the same as that of the standard motor.
- Note that operation characteristic in the chart below cannot be obtained if V/F control is used.

◆ **Standard specifications (indoor type)**

Output (kW)	Number of poles	Frequency range	Common specification
0.4	4	3 to 120 Hz	Base frequency 60 Hz • Rotation direction (CCW) Counterclockwise when viewed from the motor end • Lead wire 3.7 kW or lower: 3 wires 5.5 kW or higher: 6 or 12 wires • Surrounding air temperature: 40°C or lower The protective structure is IP44.
0.75			
1.5			
2.2			
3.7			
5.5			
7.5			
11		3 to 100 Hz	
15			
18.5			
22			
30			
37		3 to 65 Hz	
45			
55			

◆ **Motor torque**

The following shows torque characteristics of the motor in combination with the inverter with the ND rating. The overload capacity decreases for the LD rating. Observe the specified range of the inverter.

◆ **Continuous rated range of use (Real sensorless vector control)**

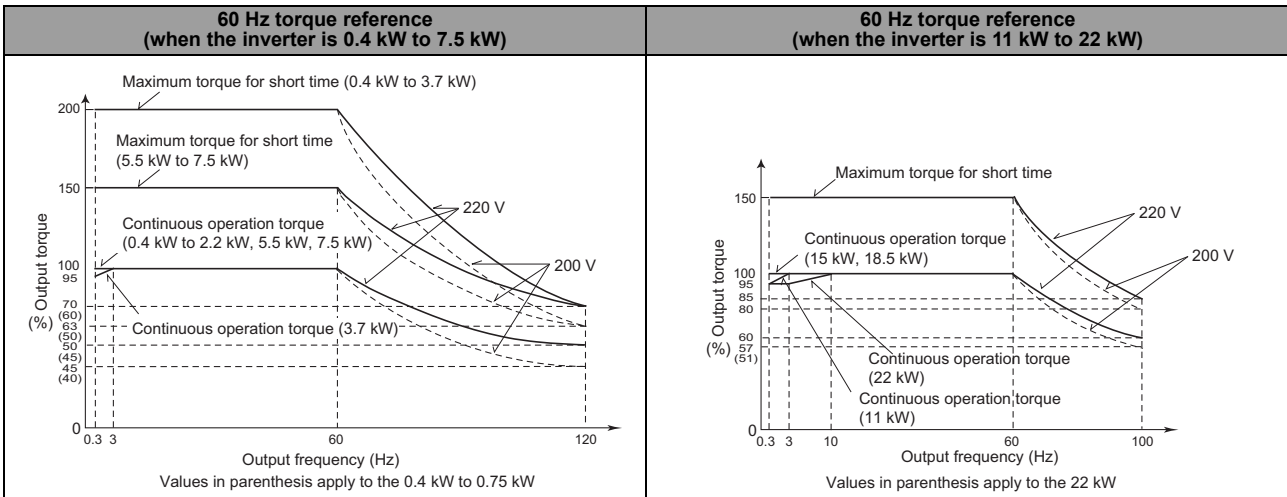

The maximum short-time torque indicates the maximum torque characteristics within 60 s. For the motor constant under Real sensorless vector control, please contact your sales representative.

◆ Specification comparison between PM sensorless vector control and induction motor control

Item	PM sensorless vector control	Induction motor control
Applicable motor	IPM motor, SPM motor *1	Induction motor *1
Starting torque	50%	200% (FR-E820-0175(3.7K) or less, FR-E840-0095(3.7K) or less, FR-E860-0061(3.7K) or less) 150% (FR-E820-0240(5.5K) or higher, FR-E840-0120(5.5K) or higher, FR-E860-0090(5.5K) or higher) under Real sensorless vector control and vector control
Startup delay	Startup delay of about 0.1 s for magnetic pole position detection.	No startup delay (when online auto tuning is not performed at startup).
Driving by the commercial power supply	Cannot be driven by the commercial power supply.	Can be driven by the commercial power supply.
Operation during coasting	While the motor is coasting, potential is generated across motor terminals.	While the motor is coasting, potential is not generated across motor terminals.
Torque control	Not available	Available under Real sensorless vector control

*1 For the motor capacity, the rated motor current should be equal to or less than the rated inverter current. (Note that the motor rated current should be 0.4 kW or higher (0.1 kW or higher for the 200 V class).) If a motor with substantially low rated current compared with the inverter rated current is used, speed and torque accuracies may deteriorate due to torque ripples, etc. Set the rated motor current to about 40% or higher of the inverter rated current.

 **NOTE**

- Before wiring, make sure that the motor is stopped. Otherwise an electric shock may occur.
- Never connect an IPM motor to the commercial power supply.
- No slippage occurs with an IPM motor because of its characteristic. If an IPM motor, which took over an induction motor, is driven at the same speed as for the induction motor, the running speed of the IPM motor becomes faster by the amount of the induction motor's slippage. Adjust the speed command to run the IPM motor at the same speed as the induction motor, as required.

● Countermeasures against deterioration of the 400 V class motor insulation

When driving a 400 V class motor by the inverter, surge voltages attributable to the wiring constants may occur at the motor terminals, deteriorating the insulation of the motor. When the 400 V class motor is driven by the inverter, consider the following countermeasures:

◆ With induction motor

It is recommended to take one of the following countermeasures:

◆ Rectifying the motor insulation and limiting the PWM carrier frequency according to the wiring length

For the 400 V class motor, use an insulation-enhanced motor.

Specifically,

- Order a "400 V class inverter-driven insulation-enhanced motor".
- For the dedicated motor such as the constant-torque motor and low-vibration motor, use an "inverter-driven dedicated motor".
- Set **Pr.72 PWM frequency selection** as indicated below according to the wiring length.

Wiring length 50 m or shorter	Wiring length 50 m to 100 m	Wiring length Longer than 100 m
14.5 kHz or lower	8 kHz or lower	2 kHz lower

◆ Suppressing the surge voltage on the inverter side

- Connect a surge voltage suppression filter (FR-ASF-H/FR-BMF-H) at the output side of the inverter.

◆ With PM motor

Use the wiring length of 100 m or shorter when connecting a PM motor.

Use one PM motor for one inverter. Multiple PM motors cannot be connected to an inverter.

When the wiring length exceeds 50 m for a 400 V class motor driven by an inverter under PM sensorless vector control, set "9" (6 kHz) or less in Pr.72 PWM frequency selection.



- A surge voltage suppression filter (FR-ASF-H/FR-BMF-H) can be used under V/F control and Advanced magnetic flux vector control.

● Application to special motors

◆ Motors with brake

Use the motor with brake having independent power supply for the brake, connect the brake power supply to the inverter primary side power and make the inverter output off using the output stop terminal (MRS) when the brake is applied (motor stop). Rattle may be heard according to the type of the brake in the low speed region but it is not a fault.

◆ Pole changing motor

As this motor differs in rated current from the standard motor, confirm the maximum current of the motor and select the inverter. Be sure to change the number of poles after the motor has stopped. If the number of poles is changed during rotation, the regenerative overvoltage protection circuit may be activated to cause an inverter alarm, coasting the motor to a stop.

◆ Submersible motor

Since the motor rated current is larger than that of the standard motor, make selection of the inverter capacity carefully. In addition, the wiring distance between the motor and inverter may become longer, refer to **page 90** to perform wiring with a cable thick enough. Leakage current may flow more than the land motor, take care when selecting the earth leakage current breaker.

◆ Explosion-proof motor

To drive an explosion-proof type motor, an explosion-proof test of the motor and inverter together is necessary. The test is also necessary when driving an existing explosion-proof motor.

The inverter is a non-explosion proof structure, install it in a safety location.

◆ Geared motor

The continuous operating rotation range of this motor changes depending on the lubrication system and maker. Especially in the case of oil lubrication, continuous operation in the low-speed range only can cause gear seizure. For fast operation at higher than 60 Hz, please consult the motor maker.

◆ Synchronous motor other than PM motor

This motor is not suitable for applications of large load variation or impact, where out-of-sync is likely to occur. Please contact your sales representative when using this motor because its starting current and rated current are greater than those of the standard motor and will not rotate stably at low speed.

◆ Single phase motor

The single phase motor is not suitable for variable operation by the inverter.

For the capacitor starting system, the capacitor may be damaged due to harmonic current flowing to the capacitor. For the split-phase starting system and repulsion starting system, not only output torque is not generated at low speed but it will result in starting coil burnout due to failure of centrifugal force switch inside. Replace with a three-phase motor for use.

Compatibility

● Major differences from the FR-E700 series

Item		FR-E800	FR-E700
Multiple rating		Two ratings (LD/ND)	N/A (ND rating only)
Permissible load	ND rating	150% 60 s, 200% 3 s at surrounding air temperature of 50°C	
	LD rating	120% 60 s, 150% 3 s at surrounding air temperature of 50°C	N/A
Built-in brake transistor		200 V class: 0.4K to 22K 400V class: 0.4K to 22K 575V class: 0.75K to 7.5K	200 V class: 0.4K to 15K 400V class: 0.4K to 15K
Control method	—	Soft-PWM control / High carrier frequency PWM	
	V/F control	Available	
	Advanced magnetic flux vector control	Available	
	General-purpose magnetic flux vector control	Not available	Available
	Real sensorless vector control	Available	Not available
Control mode	Speed control	Available	
	Torque control	Available	Not available
Output frequency		0.2 to 590 Hz (under V/F control) 0.2 to 400 Hz (under other than V/F control)	0.2 to 400 Hz
Frequency setting resolution	Terminal 2	0.015 Hz / 0 to 60 Hz (0 to 10 V / 12 bits) 0.03 Hz / 0 to 60 Hz (0 to 5 V / 11 bits) 0.03 Hz / 0 to 60 Hz (0 to 20 mA / 11 bits)	0.06 Hz / 0 to 60 Hz (0 to 10 V / 10 bits) 0.12 Hz / 0 to 60 Hz (0 to 5 V / 9 bits)
	Terminal 4	0.015 Hz / 0 to 60 Hz (0 to 10 V / 12 bits) 0.03 Hz / 0 to 60 Hz (0 to 5 V / 11 bits) 0.03 Hz / 0 to 60 Hz (0 to 20 mA / 11 bits)	0.06 Hz / 60 Hz (0 to 10 V / 10 bits) 0.12 Hz / 60 Hz (0 to 5 V / 9 bits) 0.06 Hz / 60 Hz (0 to 20 mA / 10 bits)
Input signal	Terminal function	Major additional functions • Signals added for additional control methods/modes (e.g. MC signal for control mode switching) • Signals added for the trace function (e.g. Trace trigger input (TRG) signal) • Signals added for the PLC function (Sequence start (SQ) signal)	-
	Safety stop signal	FR-E800/FR-E800-E: Safety stop input (S1) Safety stop input (S2) Safety stop input common (PC)	Safety stop function model only. Safety stop input (S1) Safety stop input (S2) Safety stop input common (PC)
Operational functions		Major additional functions Traverse, multi-rating, PLC function, torque limit, trace function, load fault detection, Ethernet communication (incl. CC-Link IE TSN, EtherNet/IP), and others	-
Output signal	Terminal function	Major additional functions • Signals added for additional control methods/modes (e.g. Home position return completed (ZP) signal To be supported) • Signals added for the load fault detection function (e.g. Upper limit warning detection (LUP) signal) • Virtual output terminals for communication (NET Y1 to Y4)	-
	Specification of terminal FM	1440 pulses/s at full scale	
	Specification of terminal AM	-10 to +10 V / 12 bits	AM: 0 to +10 V (Provided only for inverters other than Japanese specification)
	Output signal (for terminal FM / terminal AM)	Major additional functions • Signals added for additional control methods/modes (e.g. position command To be supported, torque monitor) • PID measured value 2	-
	Output signal (for communication)	Major additional functions • Signals added for BACnet communication (e.g. signal for BACnet reception status) • Communication station number (PU port, CC-Link)	-
Safety stop function	FR-E800/FR-E800-E: • Safety monitor output (SO) • Safety stop input/output common (SOC) • The following signals can be assigned to output terminals. SAFE signal (used to monitor safety stop status) SAFE2 signal (output when a fault is detected)	The following signals can be assigned to output terminals. SAFE signal (used to monitor safety stop status) SAFE2 signal (output when a fault is detected) (Safety stop function model only.)	

Item		FR-E800	FR-E700
Protective/ warning output	Protective function	Major additional functions Upper limit fault detection (E.LUP) and others	-
	Warning function	Major additional functions Duplicate IP address (DIP), IP address fault (IP), Incorrect parameter setting (SE), and others	-
Operation panel	Standard	Operation panel equipped as standard (not removable). Four-digit display using a 7-segment LED is employed.	
	Optional	Enclosure surface operation panel (FR-PA07)	Enclosure surface operation panel (FR-PA07) Parameter unit (FR-PU07(BB))
Main circuit terminals		R, S, T, U, V, W, P, PR, N, P1, earth (ground) (screw terminal type)	
Control circuit terminal	Shape of terminal block	Spring clamp type	Standard control circuit terminal model: Screw type Safety stop function model: Spring clamp type
	Contact input	FR-E800: 7 terminals FR-E800-E: 2 terminals	Standard control circuit terminal model: 7 terminals Safety stop function model: 6 terminals
	Analog input	FR-E800: 2 terminals FR-E800-E: 2 terminals	2 terminals
	Relay output	FR-E800: 1 terminal FR-E800-E: 1 terminal	1 terminal
	Open collector output.	FR-E800: 2 terminals FR-E800-E: 0	2 terminals
	Pulse output	1 terminal (FM type only)	1 terminal
	Analog output	1 terminal (AM type only)	N/A
	Safety I/O signal	FR-E800/FR-E800-E: S1, S2, SIC, SO, SOC	S1, S2, PC (Safety stop function model only.)
Communication	Ethernet	Available, two ports CC-Link IE TSN, CC-Link IE Field Network Basic, EtherNet/IP, PROFINET, MODBUS/TCP, BACnet/ IP (provided for FR-E800-E only)	Available, one port CC-Link IE Field Network Basic MODBUS/TCP (provided for FR-E700-NE only)
	RS-485	Available, one port, Mitsubishi inverter protocol, MODBUS RTU (Not available for FR-E800-E and FR-E800-SCE)	
	USB	Available, mini B connector, USB bus power available (Maximum SCCR: 500 mA)	Available, mini B connector, USB bus power unavailable
Surrounding air temperature		200/400 V class: -20°C to +60°C (Derate the rated current when using the inverter in a temperature exceeding 50°C.) 575 V class: -10°C to +60°C (Derate the rated current when using the inverter in a temperature exceeding 50°C.)	-10°C to +50°C
Storage temperature		-40°C to +70°C	-20°C to +65°C

◆ Installation precautions

- Removal procedure of the front cover is different. (Refer to the Instruction Manual (Connection).)
- Plug-in options of the FR-A700 series are not compatible.

◆ Wiring precautions

- When the FR-E700 standard control circuit terminal model is replaced, the terminal block type is changed from the screw type to the spring clamp type.
Use of blade terminals is recommended.
- To use the PU connector, note that wiring methods are different. (Refer to the Instruction Manual (Connection).)

● Comparison with the FR-E700 series in functions

Parameter/function	Differences with the FR-E700				Remarks
	Addition	Modification	Deletion	Related parameter	
Base frequency or other functions related to output frequency		✓		Pr.3 and others	Maximum setting was changed from 400 Hz to 590 Hz. Max. 400 Hz when the control method is not V/F control.
MRS input selection		✓		Pr.17	Addition of normally closed (NC contact) input specification for terminal X10
Stall prevention operation level and related functions		✓		Pr.22, Pr.150, Pr.165	Multiple ratings LD: 120% ND: 150%
Operation panel main monitor selection, TM terminal function selection, and related functions		✓		Pr.52, Pr.54, and others	Addition of monitor items (e.g. running speed)
Frequency / rotation speed Unit switchover	✓			Pr.53	
Restart coasting time and others		✓		Pr.57, Pr.165	Change of the setting range
Remote function selection		✓		Pr.59	Remote setting enabled for deceleration to the frequency to the set frequency or lower
Retry waiting time		✓		Pr.68	<ul style="list-style-type: none"> Change of the retry waiting time Change of the operation to be performed when a fault that does not trigger a retry occurs during retry waiting time
Special regenerative brake duty		✓		Pr.70	Change of the setting range for the brake duty
Applied motor		✓		Pr.71	Addition of the premium efficiency motor SF-PR series.
Motor capacity, number of motor poles, and the like		✓		Pr.80, Pr.81, and others	Addition of 11 to 30 kW motors. 12 motor poles are supported.
Online auto tuning selection	✓			Pr.95	
Built-in potentiometer switching			✓	Pr.146	
Output current detection operation selection	✓			Pr.166, Pr.167	
I/O terminal function selection and related functions		✓		Pr.178 to Pr.192	Addition of input/output signals
NET output selection	✓			Pr.193 to Pr.196	
Control circuit board Corrosion-Attack-Level Alert System	✓			Pr.198	
PWM frequency automatic switchover	✓			Pr.260	
Brake opening current		✓		Pr.279	The setting range is extended to 400%.
Speed deviation excess detection frequency	✓			Pr.285	
Output terminal filter	✓			Pr.289	The terminal response can be adjusted.
Monitor negative output selection	✓			Pr.290	
Overspeed detection level	✓			Pr.374	
Initial communication delay time, heartbeat settings			✓	Pr.387, Pr.388, Pr.389, Pr.391, Pr.392	
PLC function	✓			Pr.414 to Pr.417, Pr.498, Pr.1150 to Pr.1199, Pr.415 to Pr.417	
Extension output terminal filter	✓			Pr.418	
Gateway address	✓			Pr.442 to Pr.445	
Digital torque command	✓			Pr.447, Pr.448	
Second motor control	✓			Pr.451, Pr.453 to Pr.462, Pr.463 and others	
Speed setting reference	✓			Pr.505	
Display estimated main circuit capacitor residual life	✓			Pr.506	
Display ABC relay contact life	✓			Pr.507	
Display power cycle life	✓			Pr.509	
PID signal operation selection	✓			Pr.553, Pr.554	
Second frequency search gain	✓			Pr.560	
Multiple rating setting	✓			Pr.570	

Parameter/function	Differences with the FR-E700				Remarks
	Addition	Modification	Deletion	Related parameter	
PID output suspension function	✓			Pr.575 to Pr.577	
Traverse function	✓			Pr.592 to Pr.597	
PID set point and related settings	✓			Pr.609, Pr.610	
Inverter output fault detection enable/disable selection	✓			Pr.631	
Brake opening current selection	✓			Pr.639	
Brake operation frequency selection	✓			Pr.640	
Speed smoothing cutoff frequency	✓			Pr.654	
SF-PR slip amount adjustment	✓			Pr.673 to Pr.675	
Input terminal filter	✓			Pr.699	The terminal response can be adjusted.
Device instance			✓	Pr.728, Pr.729	
Second motor constant and related settings	✓			Pr.737 to Pr.746	
PID unit selection	✓			Pr.759	
Operation panel monitor item selection	✓			Pr.774 to Pr.776	
Operation frequency during communication error	✓			Pr.779	
Acceleration time in low-speed range deceleration time in low-speed range	✓			Pr.791, Pr.792	
Control mode selection	✓	✓	✓	Pr.800, Pr.702 to Pr.712, Pr.717, Pr.721, Pr.724, Pr.725, and others	<ul style="list-style-type: none"> • Real sensorless vector control, PM sensorless vector control Addition • Addition of torque control • Deletion of General-purpose magnetic flux vector control • Setting value for V/F control changed to 40
Real sensorless vector control, vector control	✓			Pr.801 to Pr.810, Pr.820 to Pr.822, Pr.824 to Pr.826, Pr.830 to Pr.832, Pr.834 to Pr.836, Pr.850 and others	
Analog input offset adjustment	✓			Pr.849	
Low speed detection	✓			Pr.865	
Terminal 4 function	✓			Pr.858, Pr.932 to Pr.933	
AM output filter	✓			Pr.867	
Speed detection hysteresis	✓			Pr.870	
OLT level setting	✓			Pr.874	
Energy saving monitoring	✓			Pr.891 to Pr.899	
PID display	✓			Pr.934 to Pr.935	
Safety fault code display	✓			Pr.986	
Operation panel setting dial push monitor selection	✓			Pr.992	
Fault initiation	✓			Pr.997	
PM parameter initialization	✓			Pr.998	
Automatic parameter setting	✓			Pr.999	
Clock function	✓			Pr.1006 to Pr.1008	
Trace function	✓			Pr.1020 to Pr.1047	
Monitor filter	✓			Pr.1106 to Pr.1108	Filter for monitoring of torque, running speed, and excitation current
Inverter-to-inverter link function	✓			Pr.1124, Pr.1125	
Inverter identification enable/disable selection	✓			Pr.1399	
Ethernet communication function (CC-Link IE TSN and others)	✓			Pr.1424 to Pr.1457	FR-E700-NE supports CC-Link IE Field Network Basic, MODBUS/TCP, MELSOFT / FA product connection, and SLMP.
Load characteristics fault detection	✓			Pr.1480 to Pr.1492	

● Major differences between the standard model (FR-E800) and the Ethernet communication model (FR-E800-E)

Item		FR-E800	FR-E700
Name		Standard model	Ethernet model
Applicable motor capacity		ND rating: 0.1 to 7.5 kW LD rating: 0.2 to 11 kW (Same for FR-E800, FR-E800-E, and FR-E800-SCE)	
Output, power supply, protective structure, cooling system, approximate mass Outline dimension / Installation dimension		Same for FR-E800, FR-E800-E, and FR-E800-SCE	
Main circuit terminal		R, S, T, U, V, W, P, PR, N, P1, earth (ground) (Same for FR-E800, FR-E800-E, and FR-E800-SCE)	
Control circuit terminal	Contact input	7 terminals: STF, STR, RH, RM, RL, MRS, RES, SD, PC	2 terminals: DI0, DI1, SD, PC
	Analog input	2 terminals: 2, 4, 10, 5 (same for FR-E800, FR-E800-E)	
	Relay output	1 terminal: A, B, C (same for FR-E800, FR-E800-E)	
	Open collector Output	2 terminals: RUN, FU, SE	N/A
	Pulse output	1 terminal: FM type only	N/A
	Analog output	1 terminal: AM type only	N/A
	Safety I/O signal	1 terminal: S1, S2, SO, SOC	
Communication	Ethernet	N/A	Available, two ports CC-Link TSN, CC-Link IE Field Network Basic EtherNet/IP, PROFINET, MODBUS/TCP, BACnet/IP
	Safety communication	N/A	
	RS-485	Available, one port Mitsubishi inverter protocol MODBUS RTU	N/A
	USB	Available, mini B connector, USB bus power available	
	Option unit	1 slot CC-Link	

MEMO

MEMO

Warranty

When using this product, make sure to understand the warranty described below.

1. Warranty period and coverage

We will repair any failure or defect (hereinafter referred to as "failure") in our FA equipment (hereinafter referred to as the "Product") arisen during warranty period at no charge due to causes for which we are responsible through the distributor from which you purchased the Product or our service provider. However, we will charge the actual cost of dispatching our engineer for an on-site repair work on request by customer in Japan or overseas countries. We are not responsible for any on-site readjustment and/or trial run that may be required after a defective unit are repaired or replaced.

[Term]

The term of warranty for Product is twelve months after your purchase or delivery of the Product to a place designated by you or eighteen months from the date of manufacture whichever comes first ("Warranty Period"). Warranty period for repaired Product cannot exceed beyond the original warranty period before any repair work.

[Limitations]

- (1) You are requested to conduct an initial failure diagnosis by yourself, as a general rule. It can also be carried out by us or our service company upon your request and the actual cost will be charged. However, it will not be charged if we are responsible for the cause of the failure.
- (2) This limited warranty applies only when the condition, method, environment, etc. of use are in compliance with the terms and conditions and instructions that are set forth in the instruction manual and user manual for the Product and the caution label affixed to the Product.
- (3) Even during the term of warranty, the repair cost will be charged on you in the following cases;
 - 1) a failure caused by your improper storing or handling, carelessness or negligence, etc., and a failure caused by your hardware or software problem
 - 2) a failure caused by any alteration, etc. to the Product made on your side without our approval
 - 3) a failure which may be regarded as avoidable, if your equipment in which the Product is incorporated is equipped with a safety device required by applicable laws and has any function or structure considered to be indispensable according to a common sense in the industry
 - 4) a failure which may be regarded as avoidable if consumable parts designated in the instruction manual, etc. are duly maintained and replaced
 - 5) any replacement of consumable parts (condenser, cooling fan, etc.)
 - 6) a failure caused by external factors such as inevitable accidents, including without limitation fire and abnormal fluctuation of voltage, and acts of God, including without limitation earthquake, lightning and natural disasters
 - 7) a failure generated by an unforeseeable cause with a scientific technology that was not available at the time of the shipment of the Product from our company
 - 8) any other failures which we are not responsible for or which you acknowledge we are not responsible for

2. Term of warranty after the stop of production

- (1) We may accept the repair at charge for another seven (7) years after the production of the product is discontinued. The announcement of the stop of production for each model can be seen in our Sales and Service, etc.
- (2) Please note that the Product (including its spare parts) cannot be ordered after its stop of production.

3. Service in overseas

Our regional FA Center in overseas countries will accept the repair work of the Product; however, the terms and conditions of the repair work may differ depending on each FA Center. Please ask your local FA center for details.

4. Exclusion of loss in opportunity and secondary loss from warranty liability

Regardless of the gratis warranty term, Mitsubishi shall not be liable for compensation to:

- (1) Damages caused by any cause found not to be the responsibility of Mitsubishi.
- (2) Loss in opportunity, lost profits incurred to the user by Failures of Mitsubishi products.
- (3) Special damages and secondary damages whether foreseeable or not, compensation for accidents, and compensation for damages to products other than Mitsubishi products.
- (4) Replacement by the user, maintenance of on-site equipment, start-up test run and other tasks.

5. Change of Product specifications

Specifications listed in our catalogs, manuals or technical documents may be changed without notice.

6. Application and use of the Product

- (1) For the use of our product, its applications should be those that may not result in a serious damage even if any failure or malfunction occurs in product, and a backup or fail-safe function should operate on an external system to product when any failure or malfunction occurs.
- (2) Our product is designed and manufactured as a general purpose product for use at general industries. Therefore, applications substantially influential on the public interest for such as atomic power plants and other power plants of electric power companies, and also which require a special quality assurance system, including applications for railway companies and government or public offices are not recommended, and we assume no responsibility for any failure caused by these applications when used.
In addition, applications which may be substantially influential to human lives or properties for such as airlines, medical treatments, railway service, incineration and fuel systems, man-operated material handling equipment, entertainment machines, safety machines, etc. are not recommended, and we assume no responsibility for any failure caused by these applications when used. We will review the acceptability of the abovementioned applications, if you agree not to require a specific quality for a specific application. Please contact us for consultation.

MEMO

MEMO

Mitsubishi Electric's global FA network delivers reliable technologies and security around the world.

■ Production base
 ● Development center
 ● Global FA Center
 ▲ Mechatronics showroom
 ● Mitsubishi Electric sales office

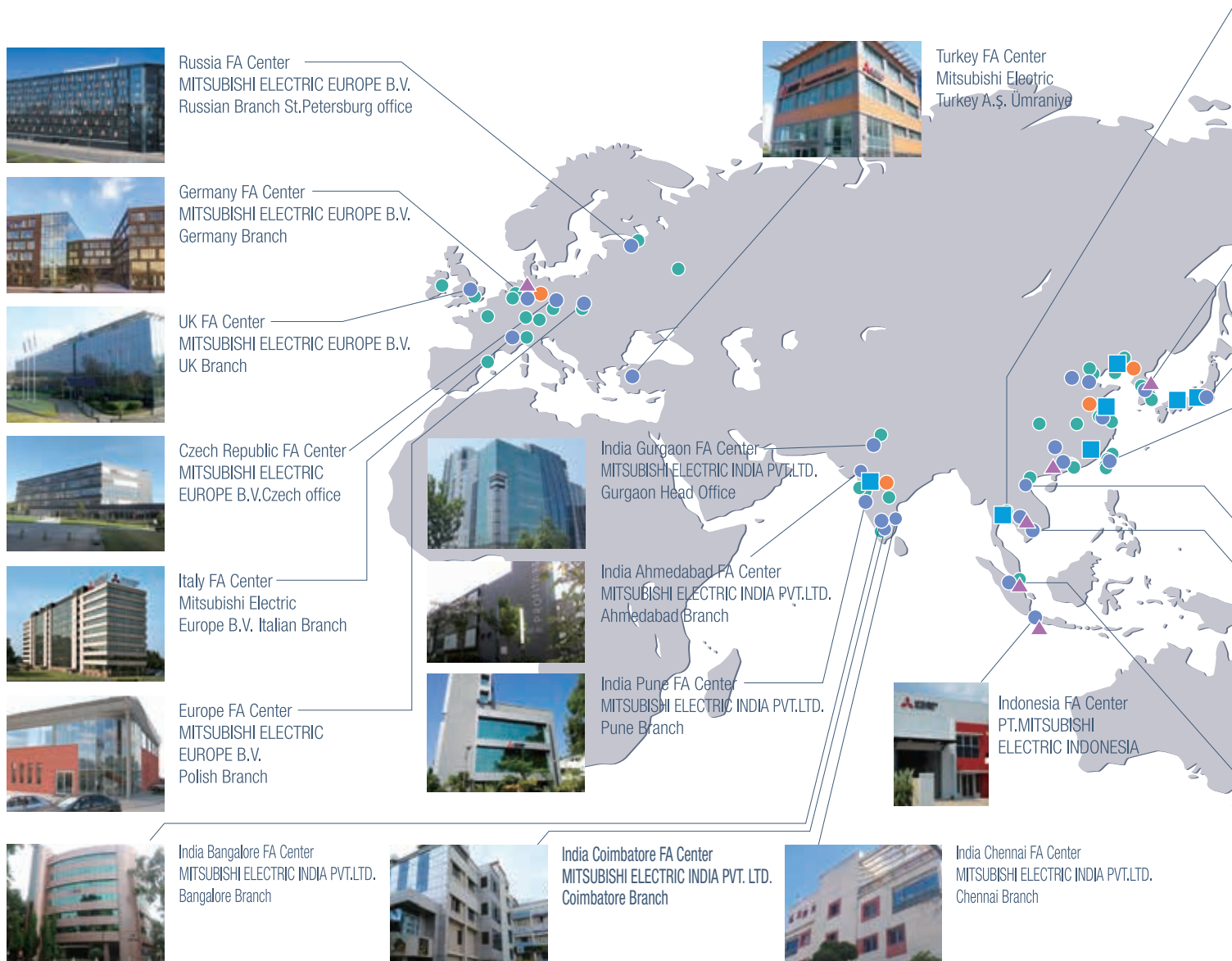

Production bases Under the lead of Nagoya Works, we form a powerful network to optimize our manufacturing processes.

Domestic bases

Nagoya Works



Shinshiro Factory
Kani Factory

Production bases overseas

MDI Mitsubishi Electric Dalian Industrial Products Co., Ltd.



MEAMC Mitsubishi Electric Automation Manufacturing (Changshu) Co., Ltd.

MEI Mitsubishi Electric India Pvt.



MEATH Mitsubishi Electric Automation (Thailand) Co., Ltd.

Thailand FA Center
MITSUBISHI ELECTRIC FACTORY
AUTOMATION (THAILAND) CO.,LTD

Korea FA Center
MITSUBISHI ELECTRIC
AUTOMATION KOREA CO.,LTD.

MITSUBISHI ELECTRIC CORPORATION
Factory Automation Systems Group

Taichung FA Center
MITSUBISHI ELECTRIC
TAIWAN CO.,LTD

Taipei FA Center
SETSUYO ENTERPRISE CO.,LTD

Ho Chi Minh FA Center
MITSUBISHI ELECTRIC
VIETNAM COMPANY
LIMITED

Hanoi FA center
Mitsubishi Electric
Vietnam
Company Limited
Hanoi Branch

ASEAN FA Center
MITSUBISHI ELECTRIC ASIA PTE.LTD.

Service bases are established around the world to provide the same services as in Japan globally. Overseas bases are opening one after another to support our customers' business expansion.

Area	Our overseas	FA centers
EMEA	26	7
China	17	4
Asia	31	13
Americas	15	6
Others	1	0
Total	90	30

As of July 2017

North America FA Center
MITSUBISHI ELECTRIC
AUTOMATION, INC.

Mexico Monterrey FA Center
Monterrey Office, Mitsubishi
Electric Automation, Inc.

Mexico FA Center
Querétaro Office, Mitsubishi
Electric Automation, Inc.

Mexico City FA Center
Mexico FA Center
Mexico Branch, Mitsubishi
Electric Automation, Inc.

Brazil FA Center
Mitsubishi Electric do Brasil
Comércio e Serviços Ltda.

Brazil Votorantim FA Center
MELCO CNC do Brasil
Comércio e Serviços S.A.

China

Beijing FA Center
MITSUBISHI ELECTRIC
AUTOMATION (CHINA)LTD.

Tianjin FA Center
MITSUBISHI ELECTRIC
AUTOMATION (CHINA)LTD.

Shanghai FA Center
MITSUBISHI ELECTRIC
AUTOMATION (CHINA) LTD.

Guangzhou FA Center
MITSUBISHI ELECTRIC
AUTOMATION (CHINA)LTD.

This solution solves customers' issues and concerns by enabling visualization and analysis that lead to improvements and increase availability at production sites.

Utilizing our FA and IT technologies and collaborating with e-F@ctory Alliance partners, we reduce the total cost across the entire supply chain and engineeringchain, and support the improvement initiatives and one-step-ahead manufacturing of our customers.



FA integrated solutions reduce total cost

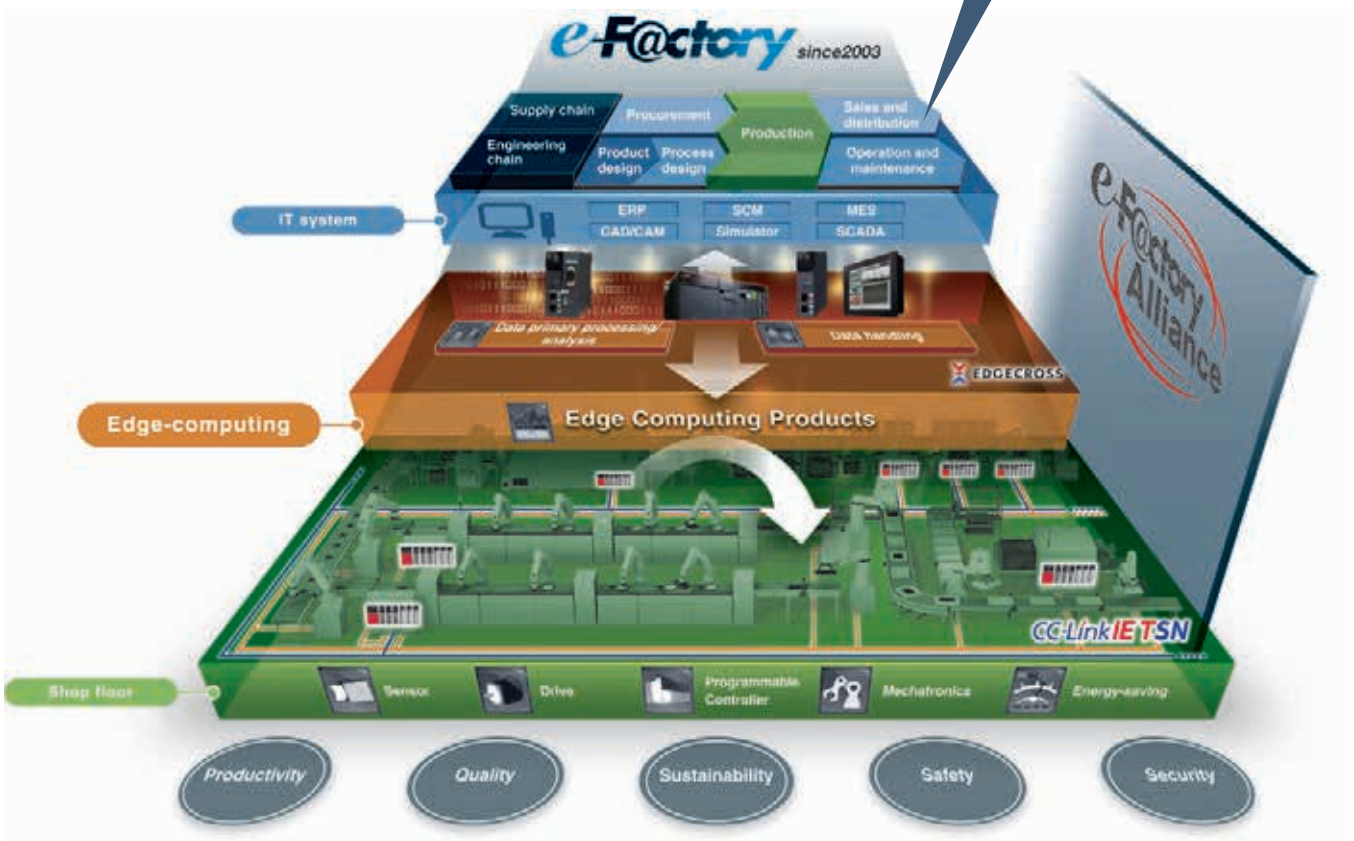
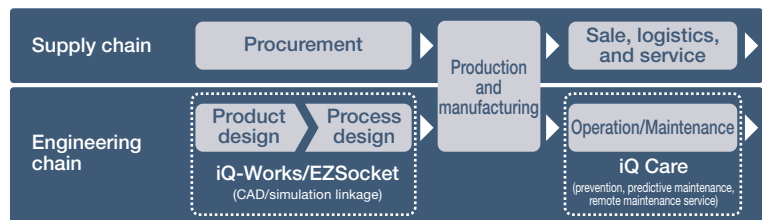

Overall production information is captured in addition to energy information, enabling the realization of efficient production and energy use (energy savings).

•Trademarks

PROFIBUS, PROFINET, and PROFIsafe are either trademarks or registered trademarks of PROFIBUS & PROFINET International. DeviceNet, EtherNet/IP, and CIP safety are either trademarks or registered trademarks of ODVA. EtherCAT is a trademark of Beckhoff Automation GmbH. Safety over EtherCAT is a trademark of Beckhoff Automation GmbH. MODBUS is a registered trademark of SCHNEIDER ELECTRIC USA, INC. BACnet is a registered trademark of the American Society of Heating, Refrigerating and Air-Conditioning Engineers (ASHRAE).

Ethernet is a registered trademark of Fuji Xerox Corporation in Japan. CC-Link IE TSN and CC-Link IE Field Network Basic are registered trademarks of CC-Link Partner Association. QR Code registered trademark of DENSO WAVE INCORPORATED. App Store is a service mark of Apple Inc. Google Play and the Google Play logo are trademarks of Google LLC. Other company and product names herein are the trademarks and registered trademarks of their respective owners.

⚠ Safety Warning

To ensure proper use of the products listed in this catalog, please be sure to read the instruction manual prior to use.

YOUR SOLUTION PARTNER

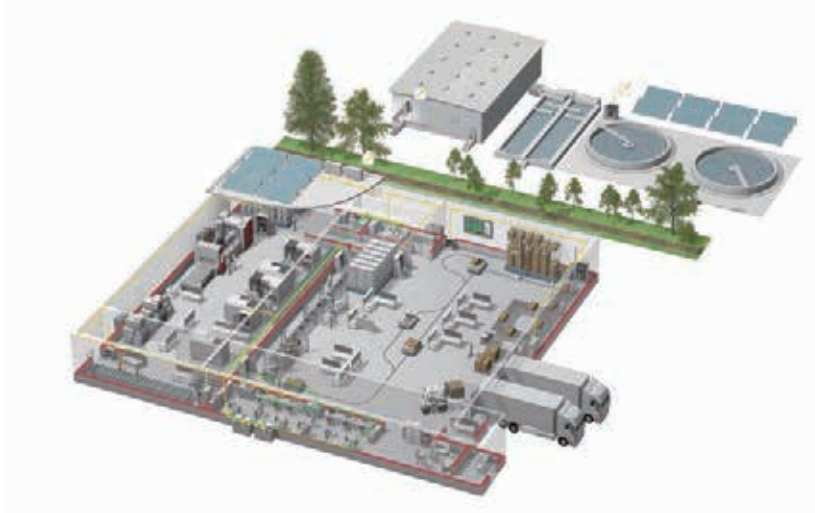

Mitsubishi Electric offers a wide range of automation equipment from PLCs and HMIs to CNC and EDM machines.

A NAME TO TRUST

Since its beginnings in 1870, some 45 companies use the Mitsubishi name, covering a spectrum of finance, commerce and industry.

The Mitsubishi brand name is recognized around the world as a symbol of premium quality.

Mitsubishi Electric Corporation is active in space development, transportation, semi-conductors, energy systems, communications and information processing, audio visual equipment and home electronics, building and energy management and automation systems, and has 237 factories and laboratories worldwide in over 121 countries.

This is why you can rely on Mitsubishi Electric automation solution - because we know first hand about the need for reliable, efficient, easy-to-use automation and control in our own factories.

As one of the world's leading companies with a global turnover of over 4 trillion Yen (over \$40 billion), employing over 100,000 people, Mitsubishi Electric has the resource and the commitment to deliver the ultimate in service and support as well as the best products.



Low voltage: MCCB, MCB, ACB



Medium voltage: VCB, VCC



Power monitoring, energy management



Compact and Modular Controllers



Inverters, Servos and Motors



Visualisation: HMIs



Numerical Control (NC)



Robots: SCARA, Articulated arm



Processing machines: EDM, Lasers, IDS



Transformers, Air conditioning, Photovoltaic systems

* Not all products are available in all countries.

Mitsubishi Electric Corporation Nagoya Works is a factory certified for ISO14001 (standards for environmental management systems) and ISO9001 (standards for quality assurance management systems)



MITSUBISHI ELECTRIC CORPORATION

HEAD OFFICE: TOKYO BLDG., 2-7-3, MARUNOUCHI, CHIYODA-KU, TOKYO 100-8310, JAPAN